



PIRATES of the CARIBBEAN

ON STRANGER TIDES



4195

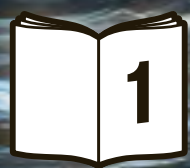

1

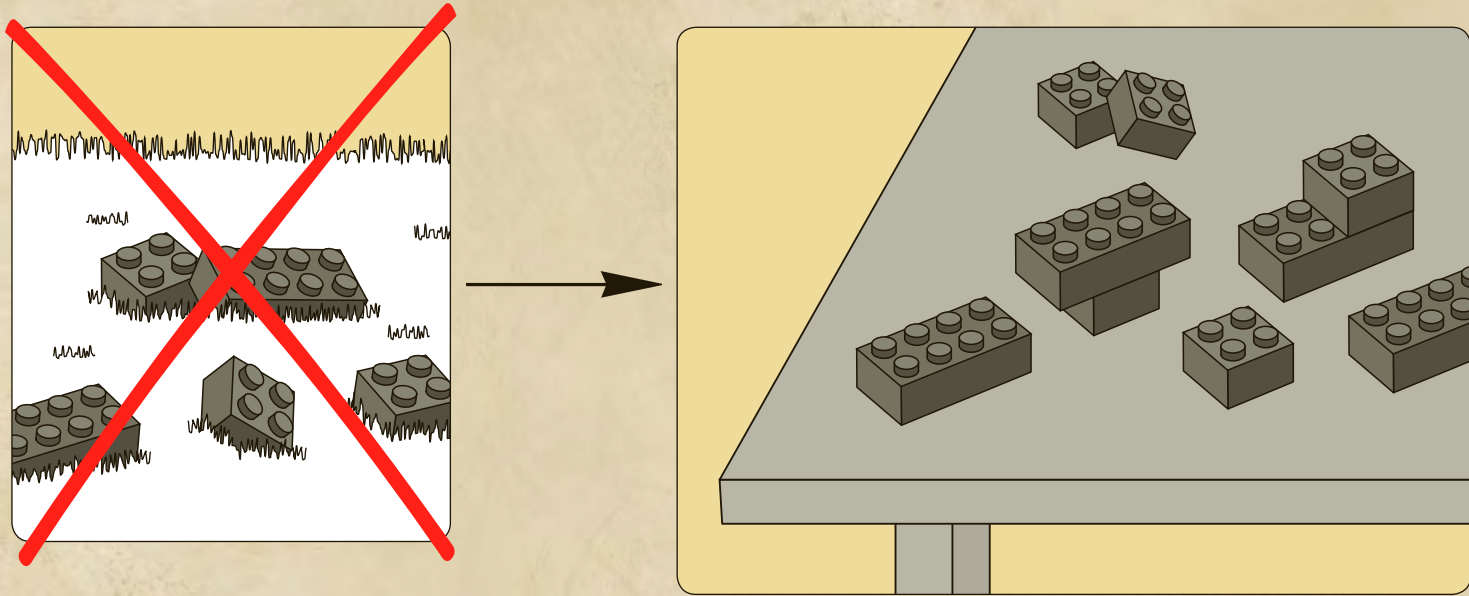

2

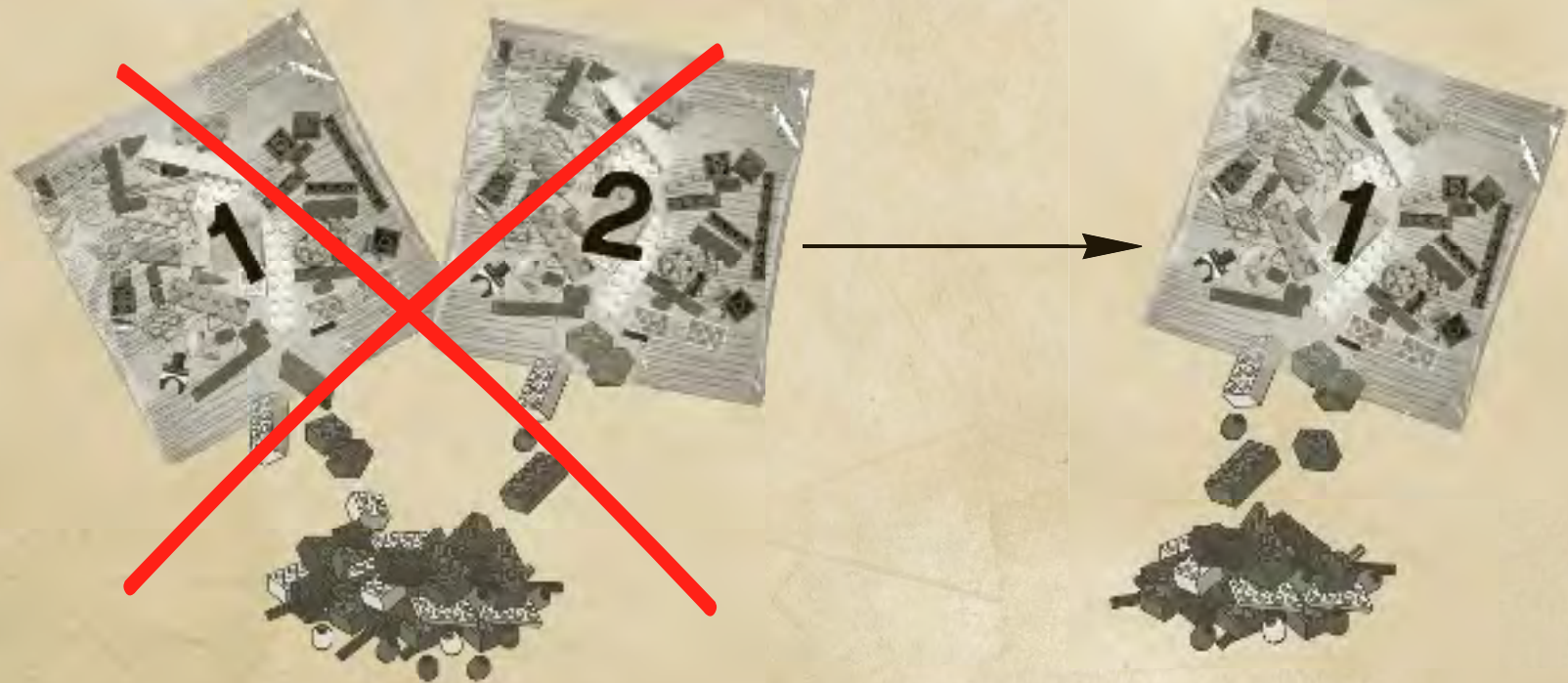



3





4

1



2

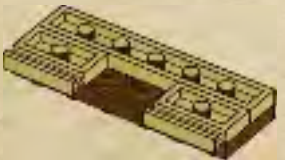

3



4

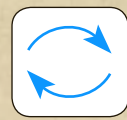

5



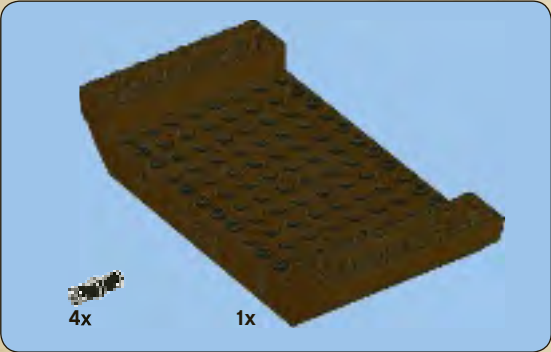
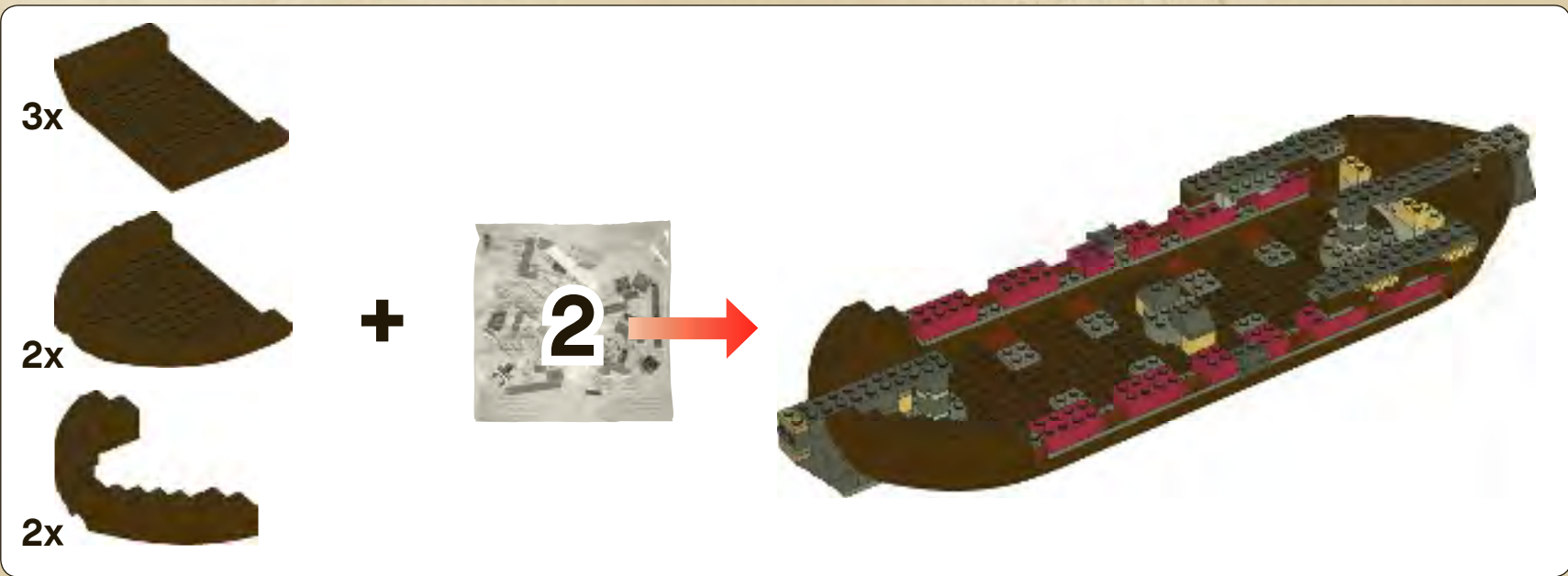

1

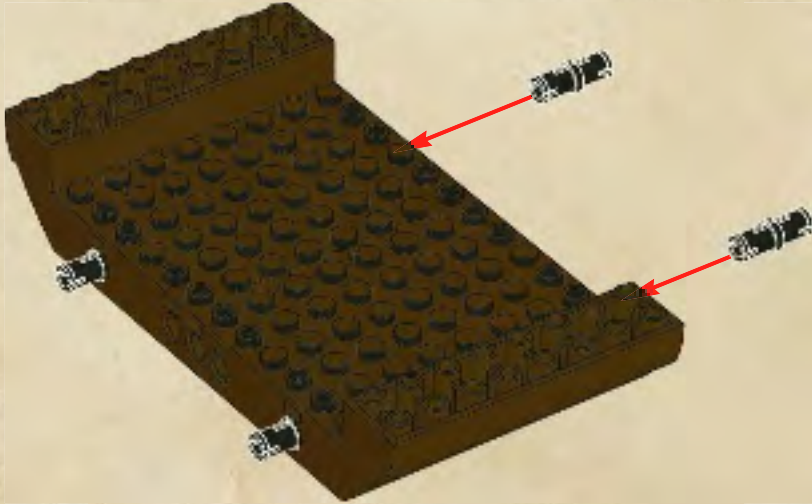

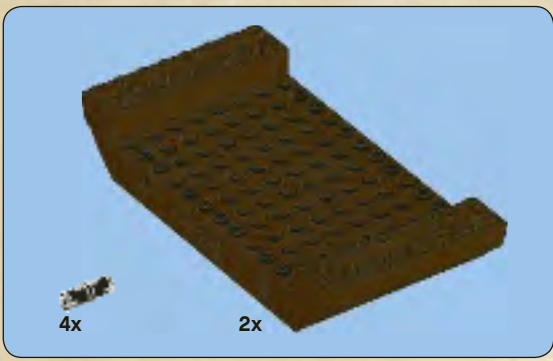

2

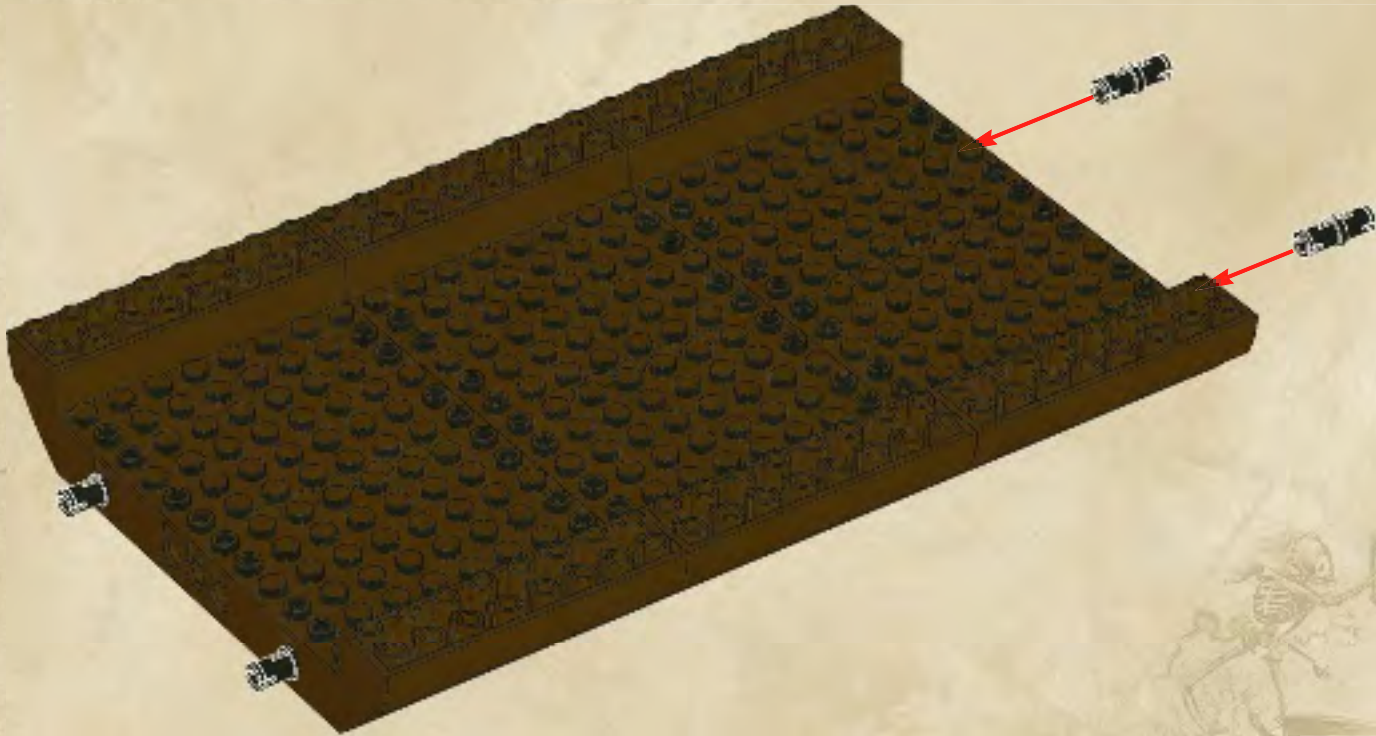

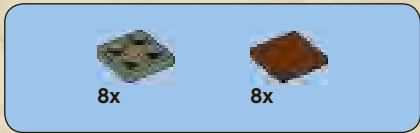

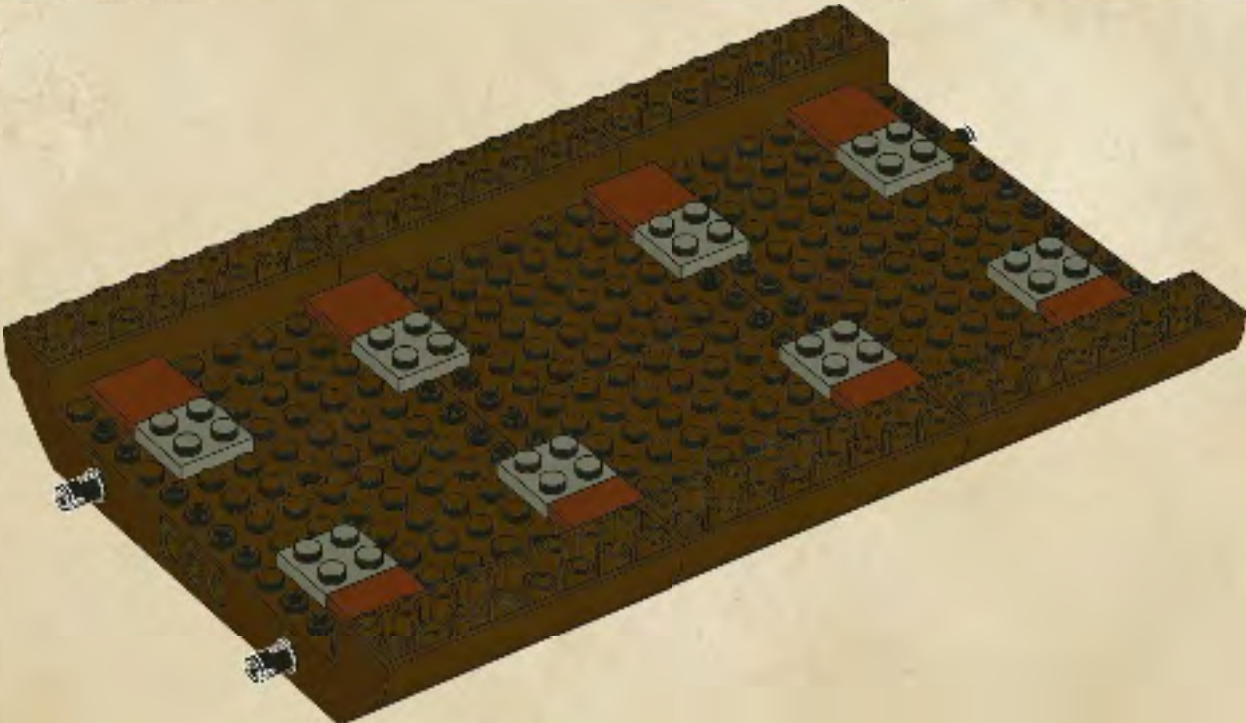

3

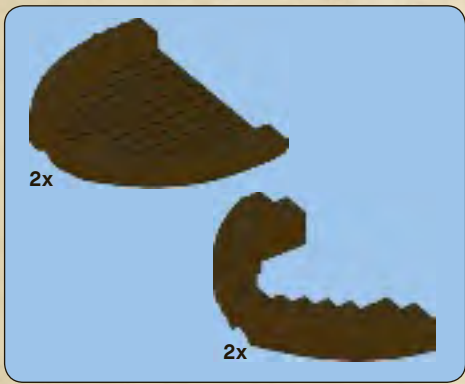

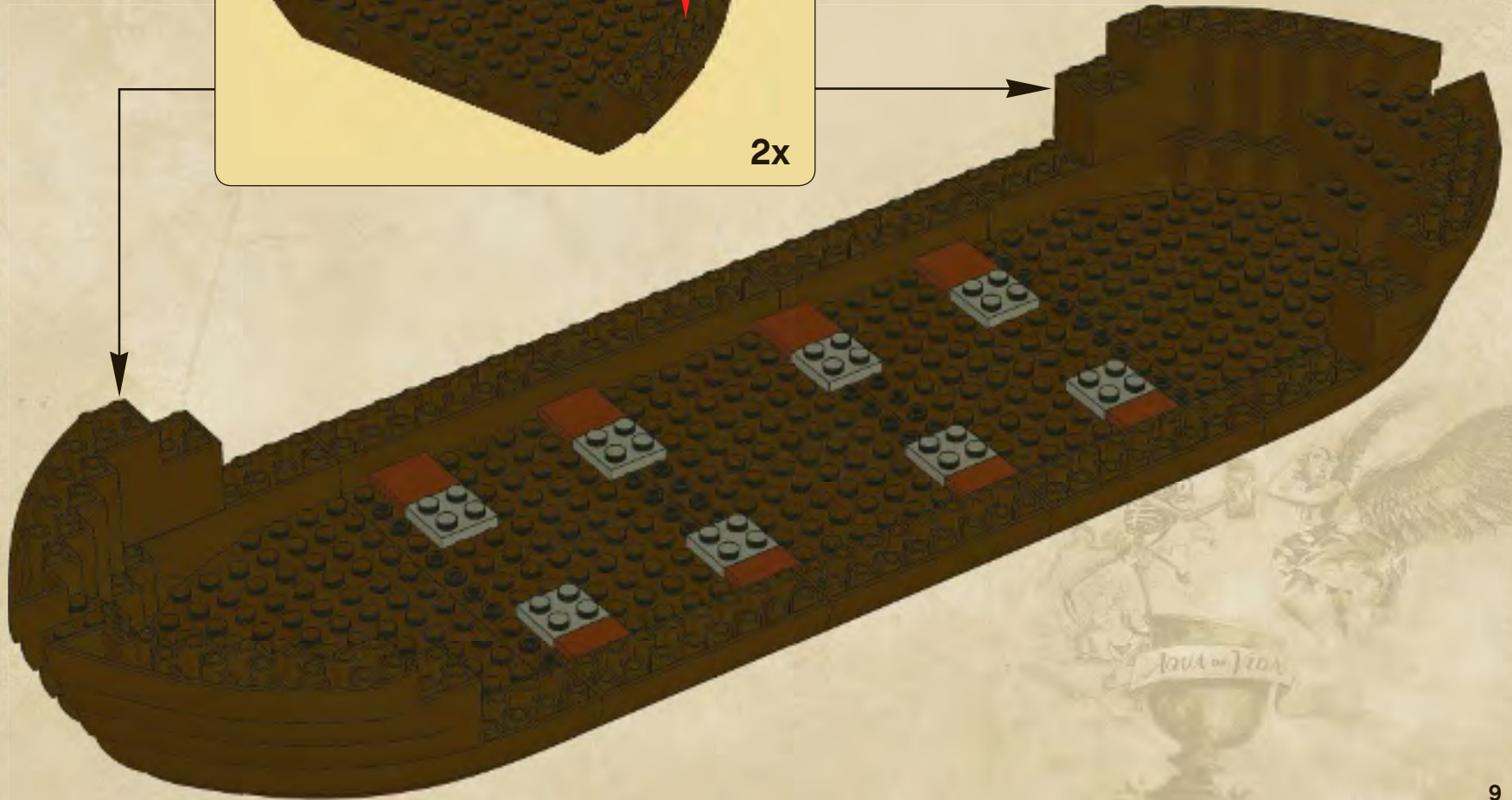
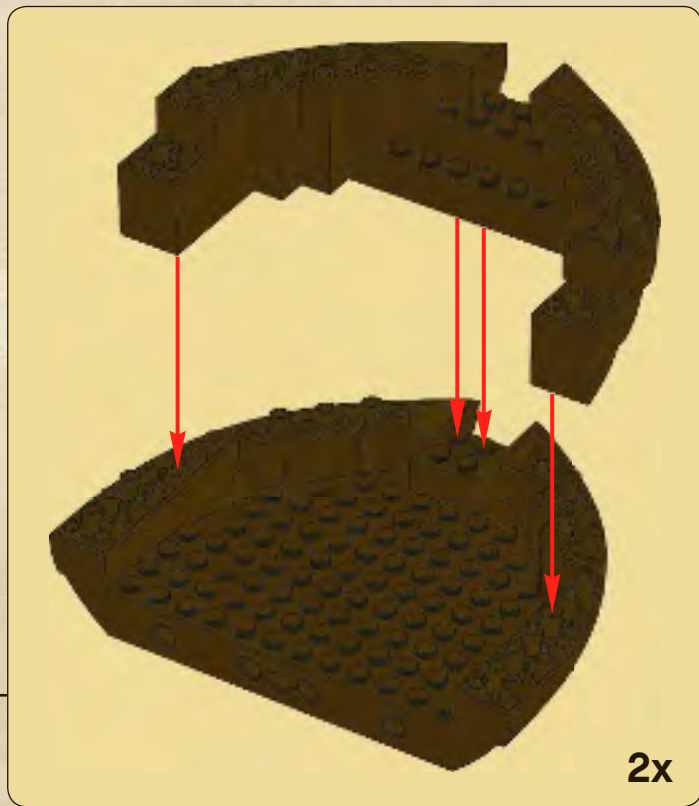

4



4x  4x 

5

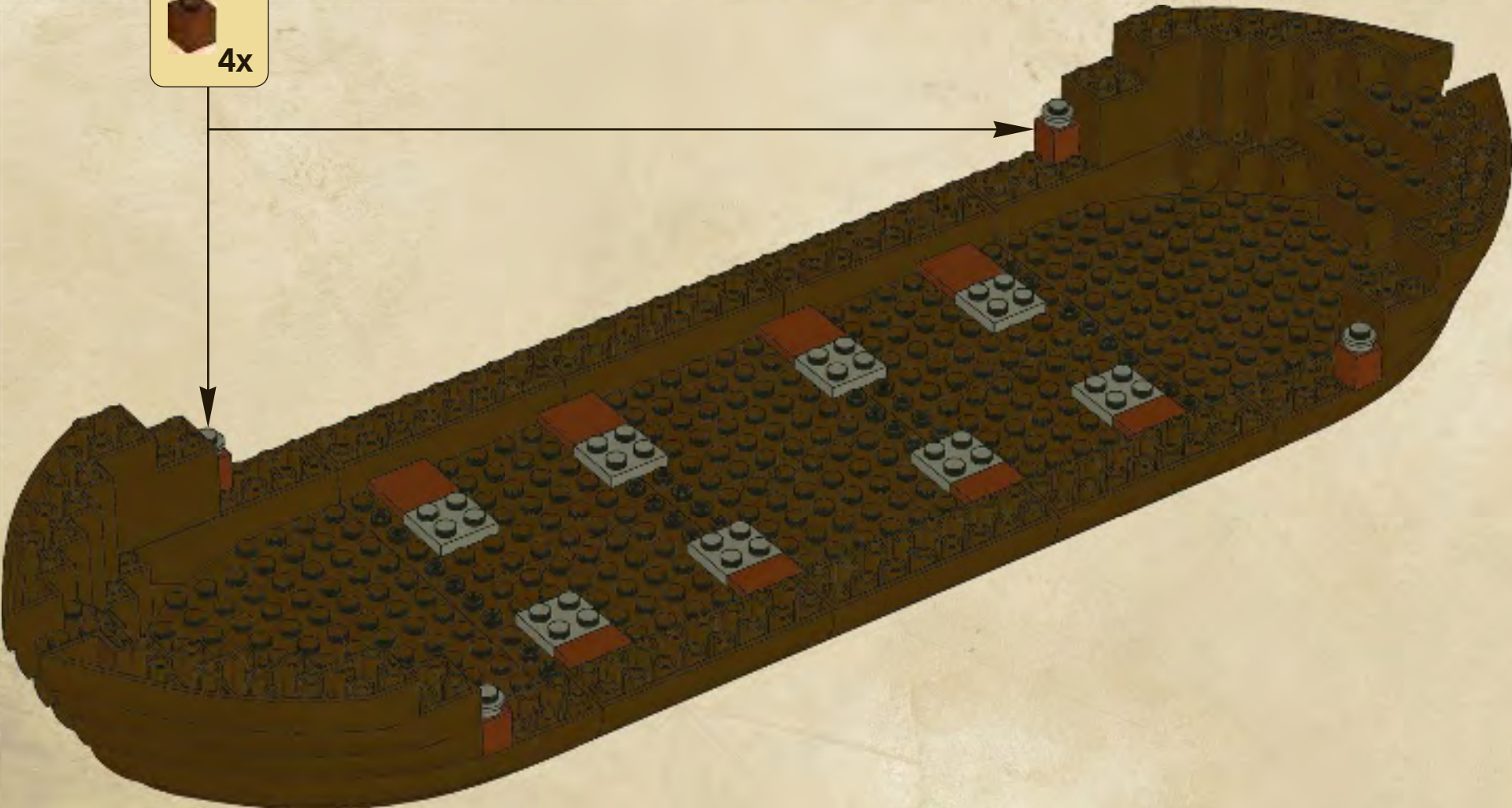

↓

4x



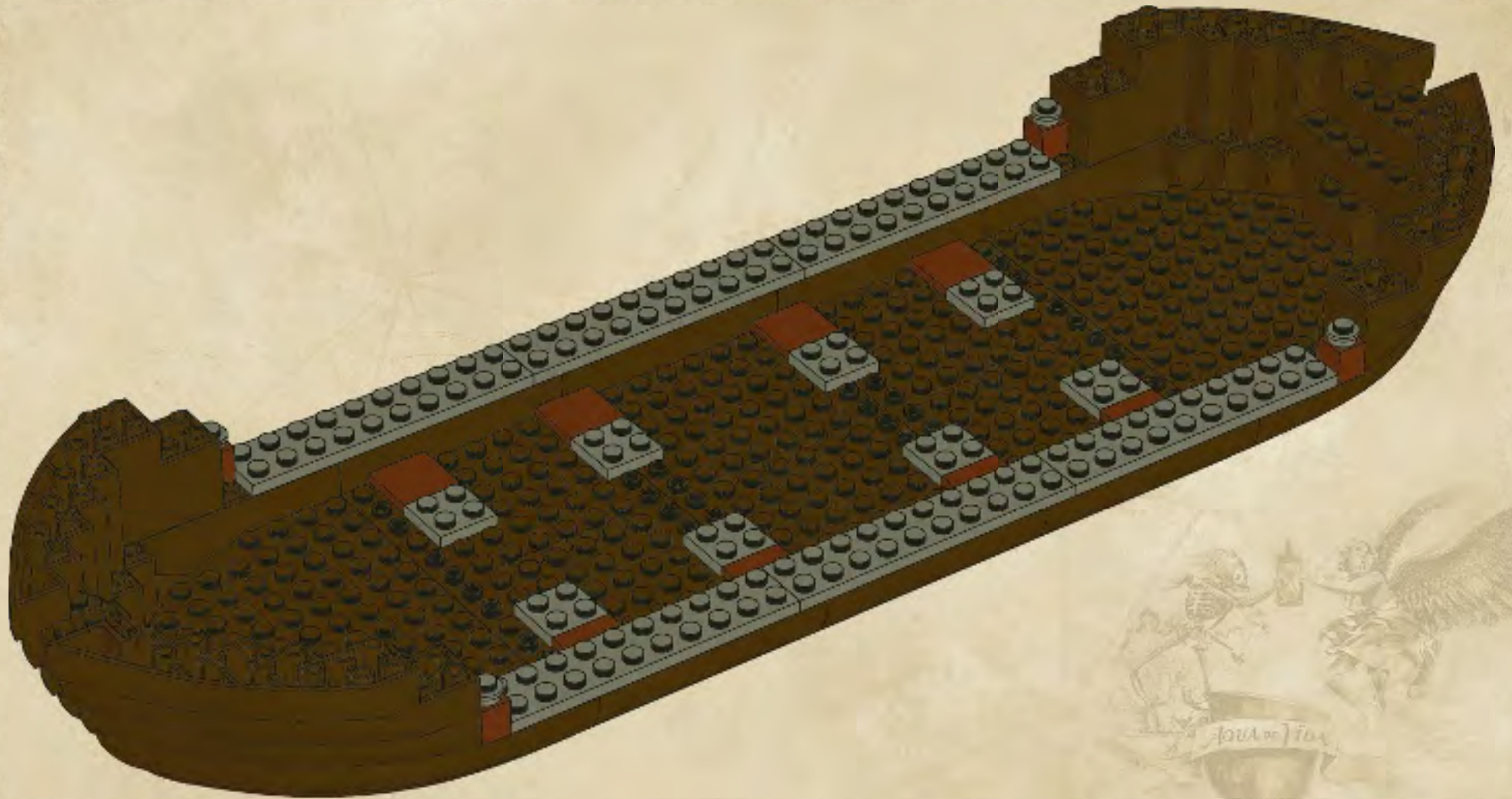

6





7

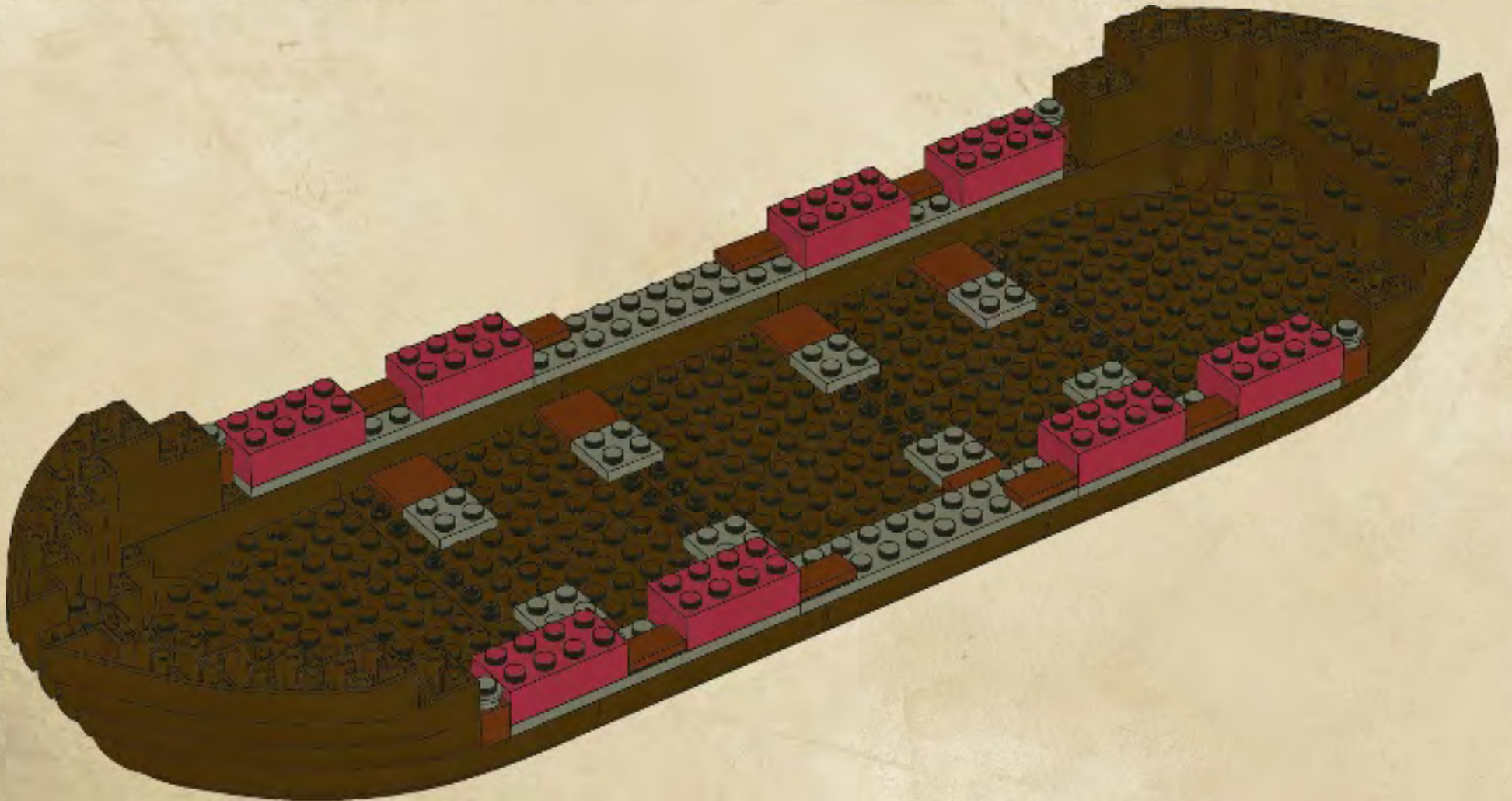



8

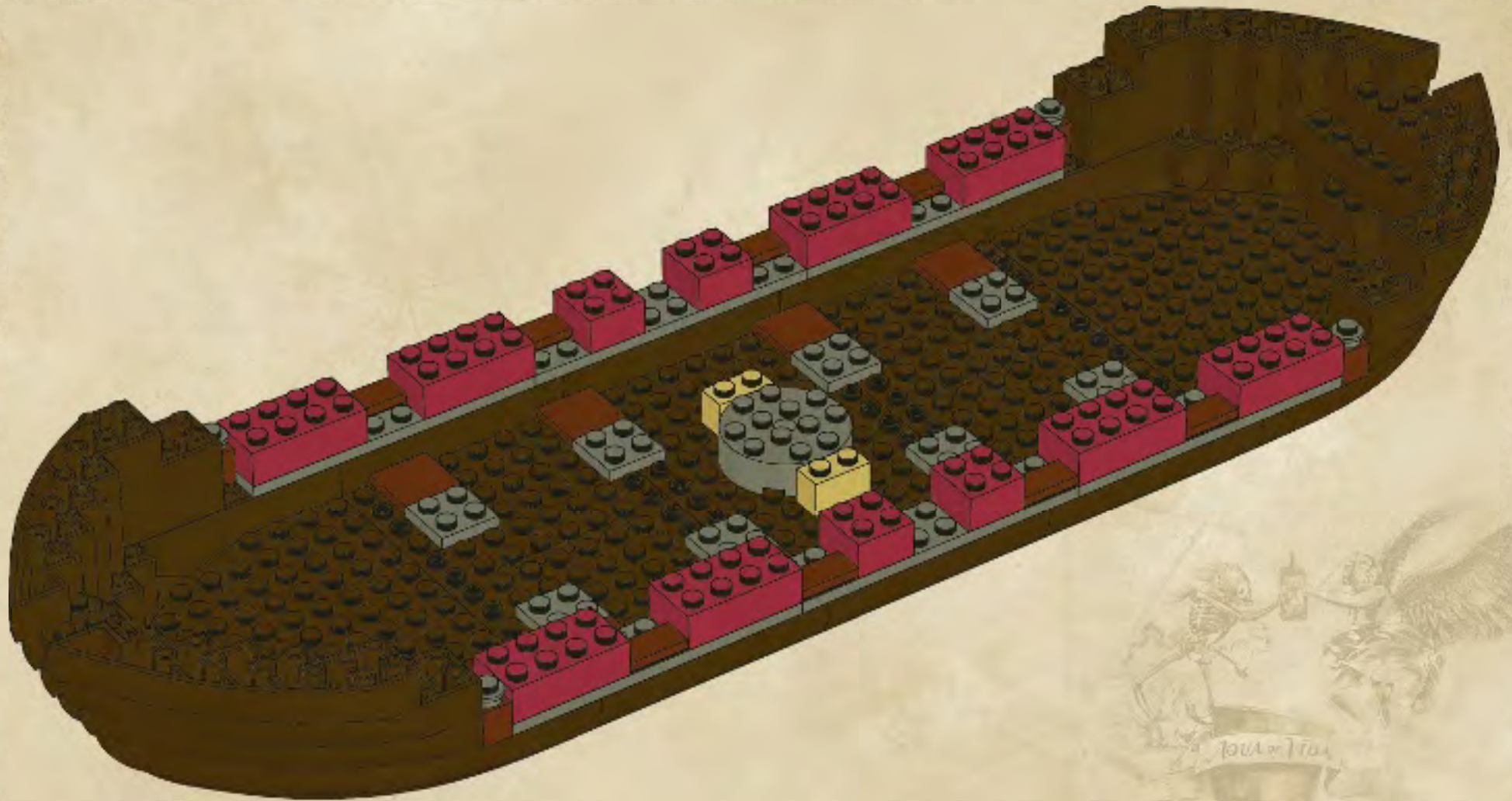

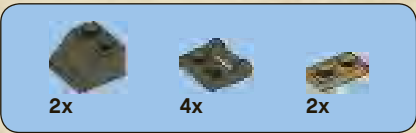

9

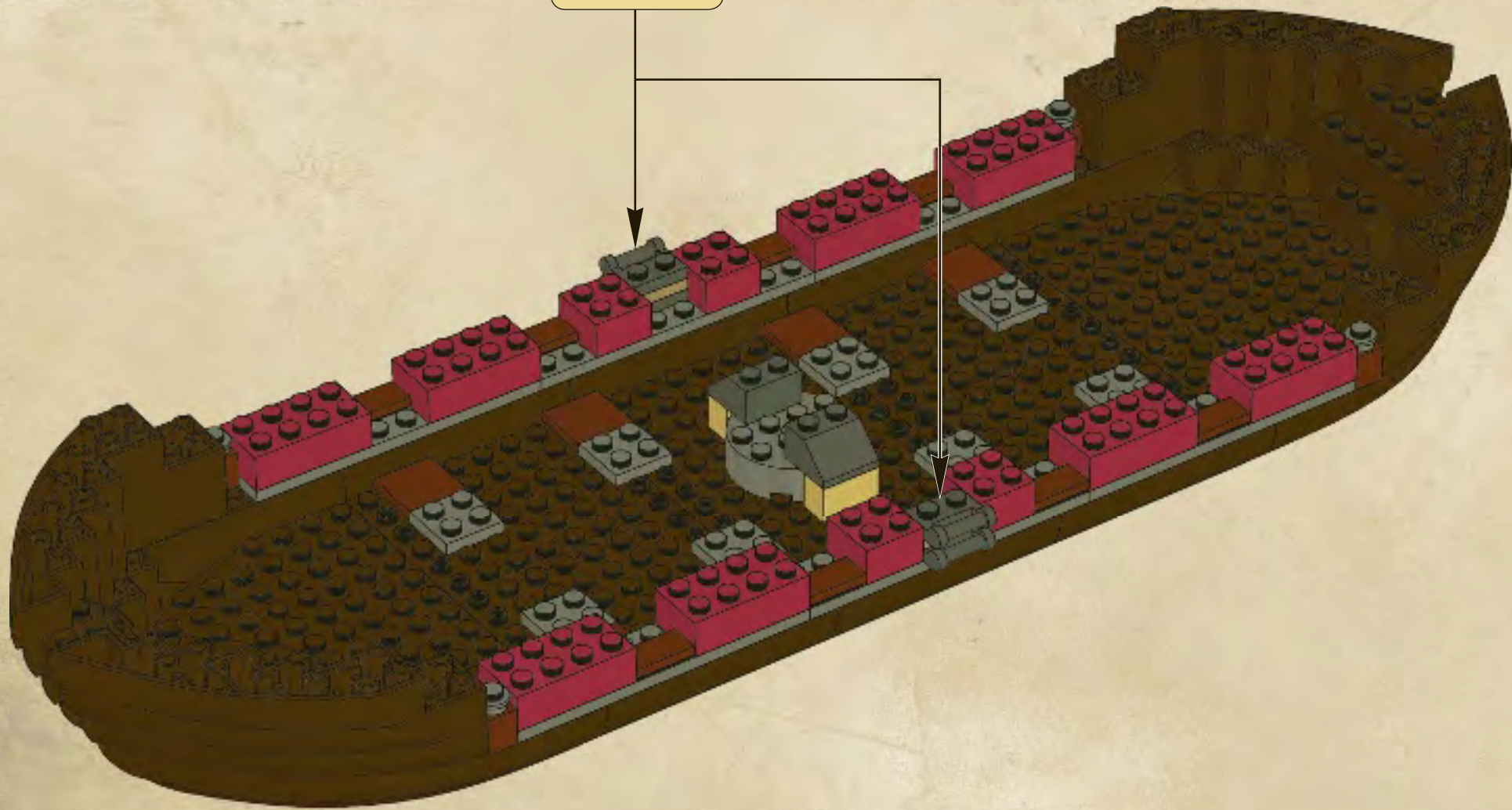
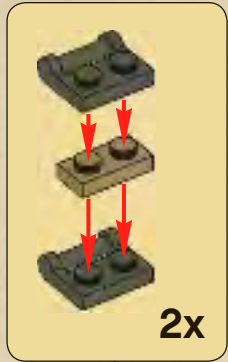

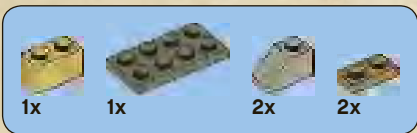

10

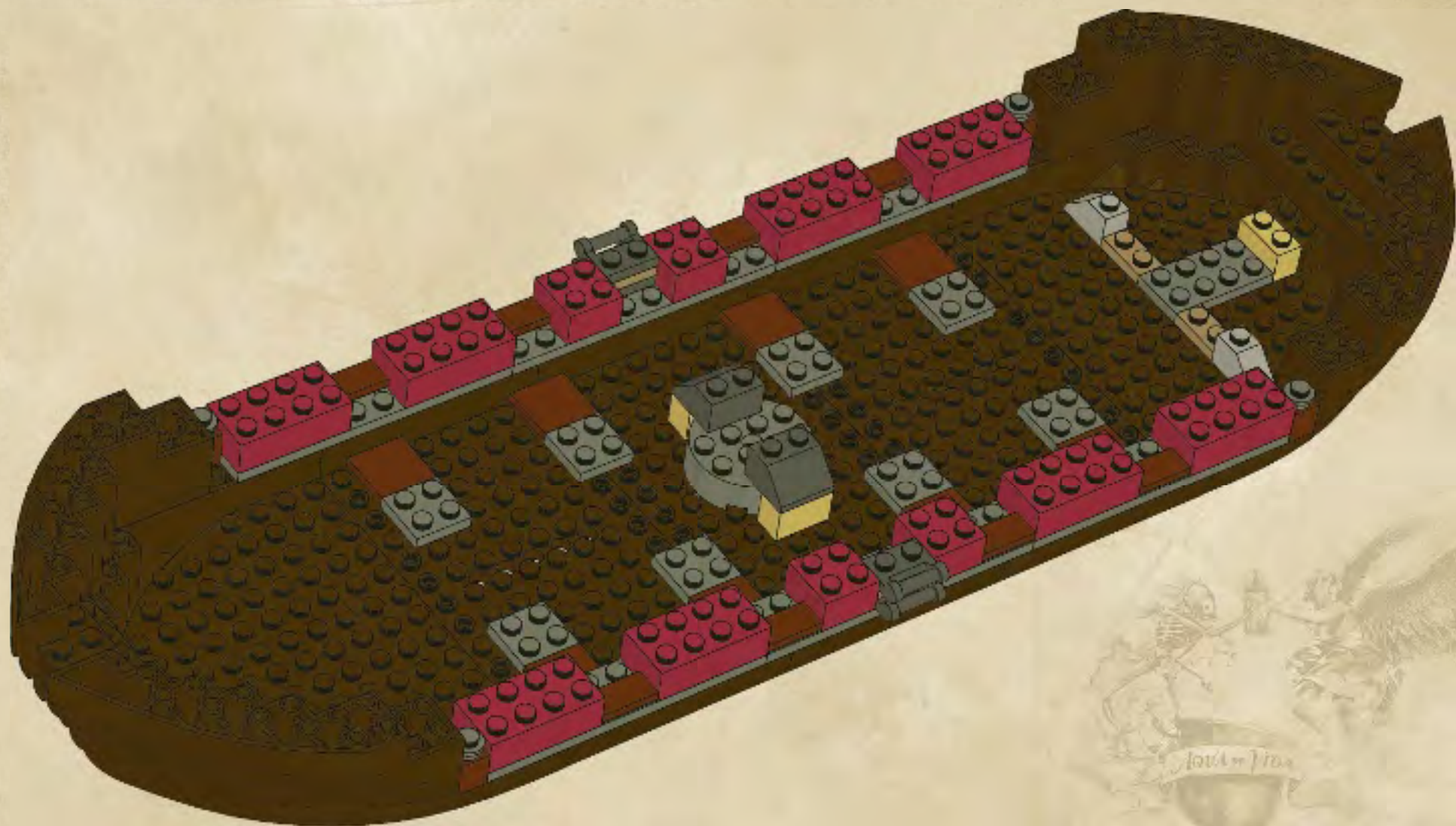

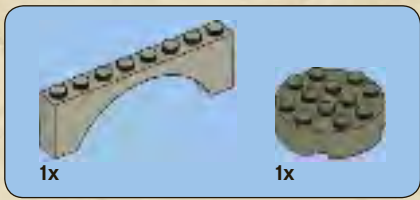

11

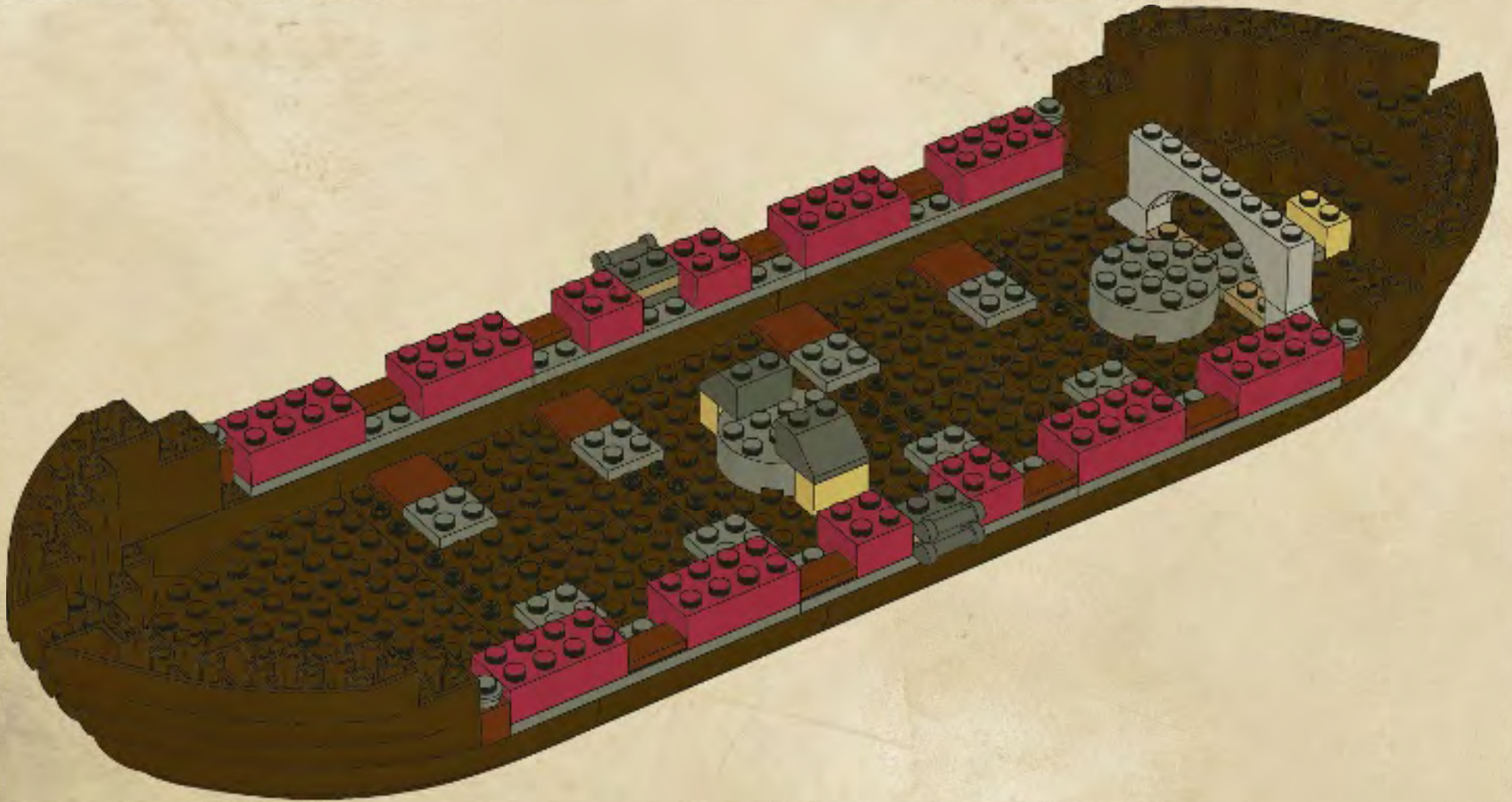

2x 1x 1x

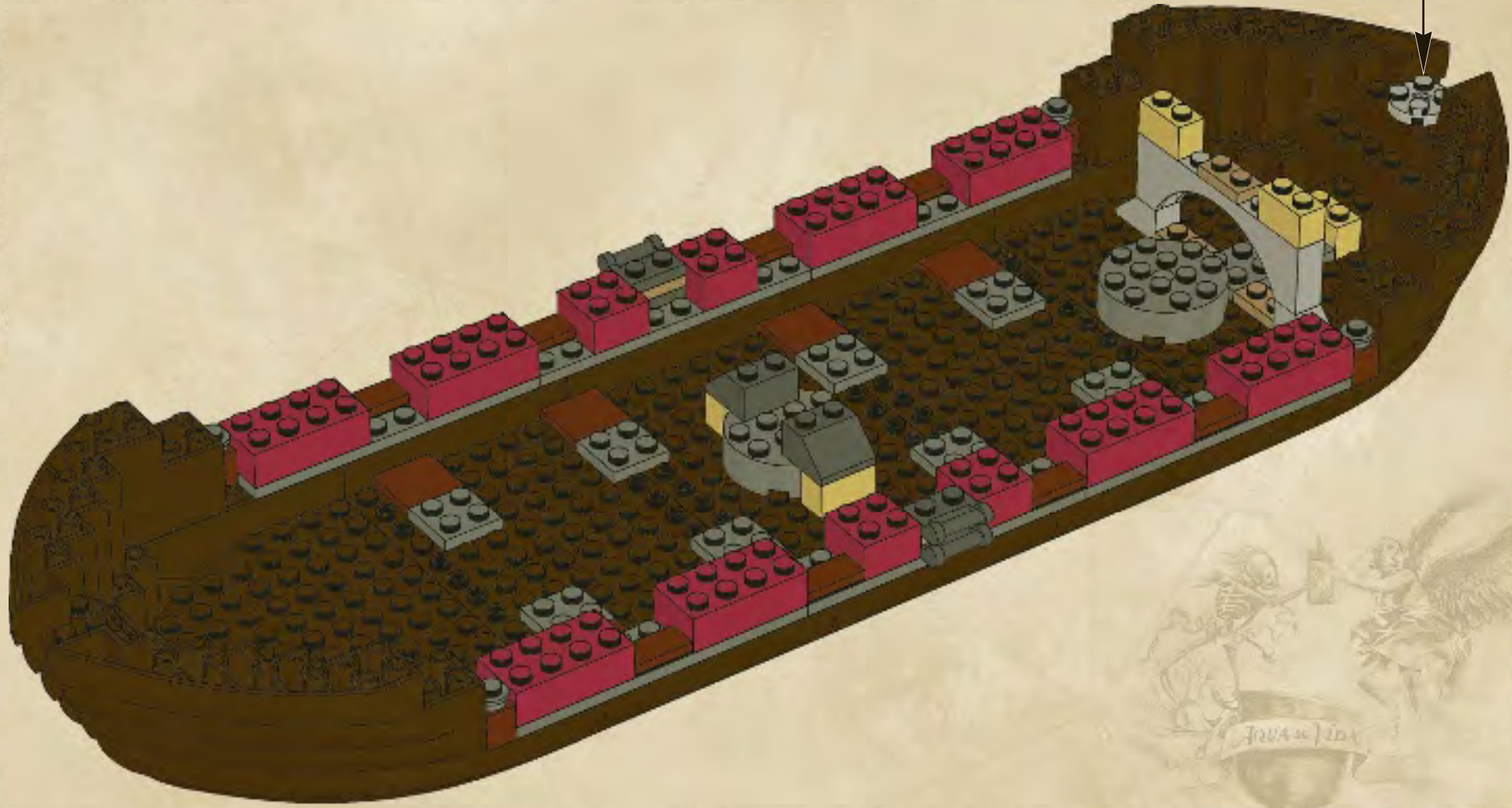

12

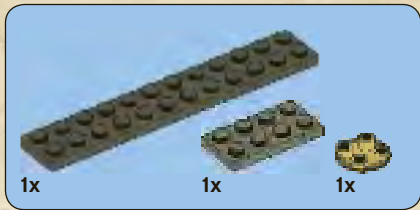

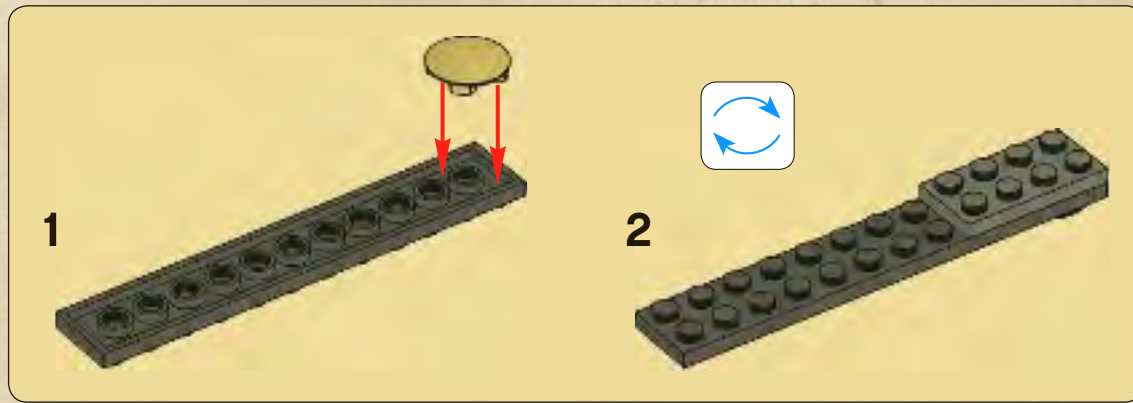

13



2x  2x 

14





15

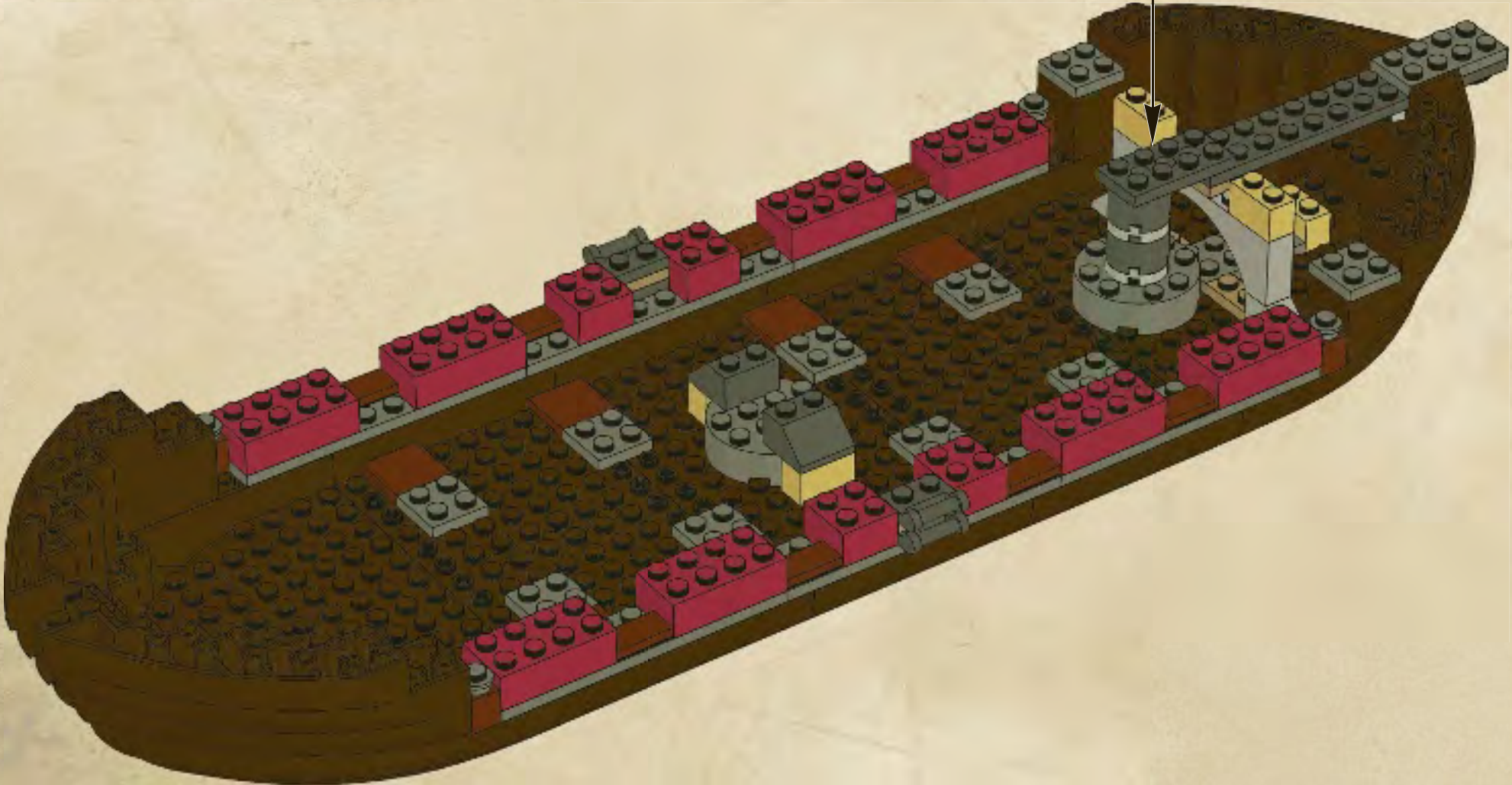

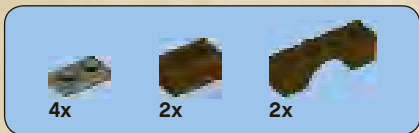

16

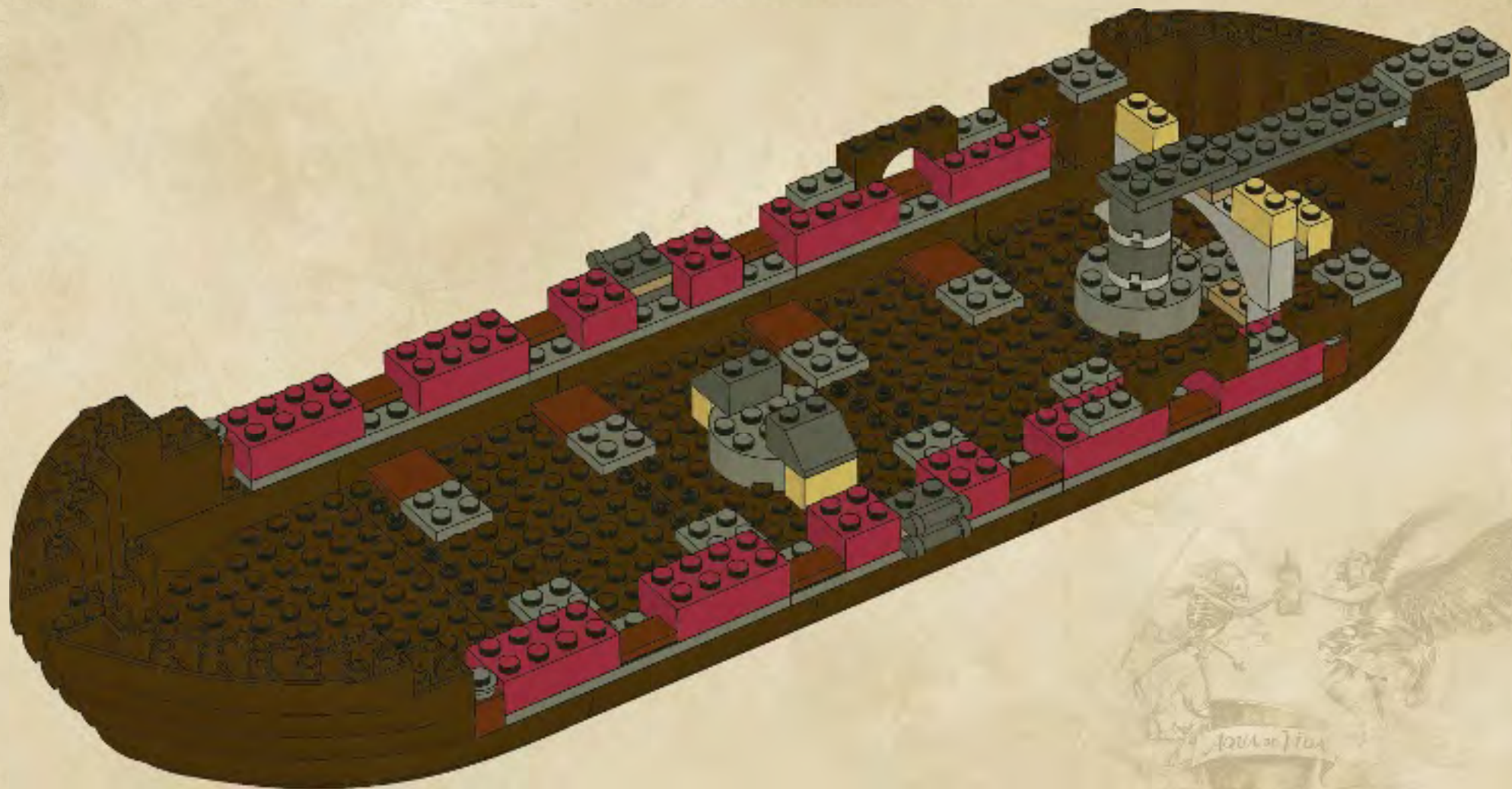



4x



4x

17

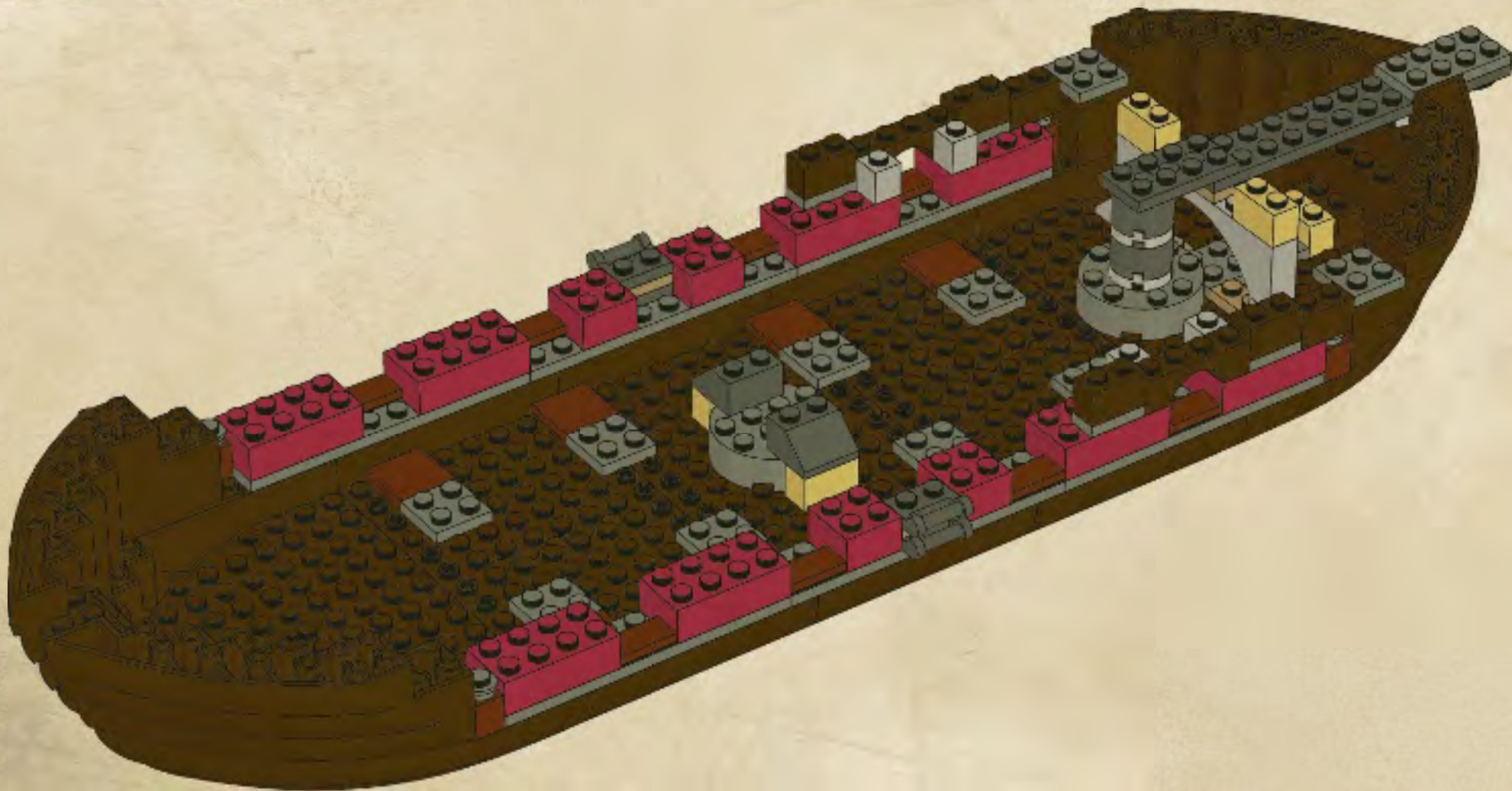

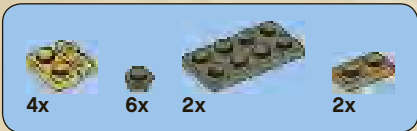

18

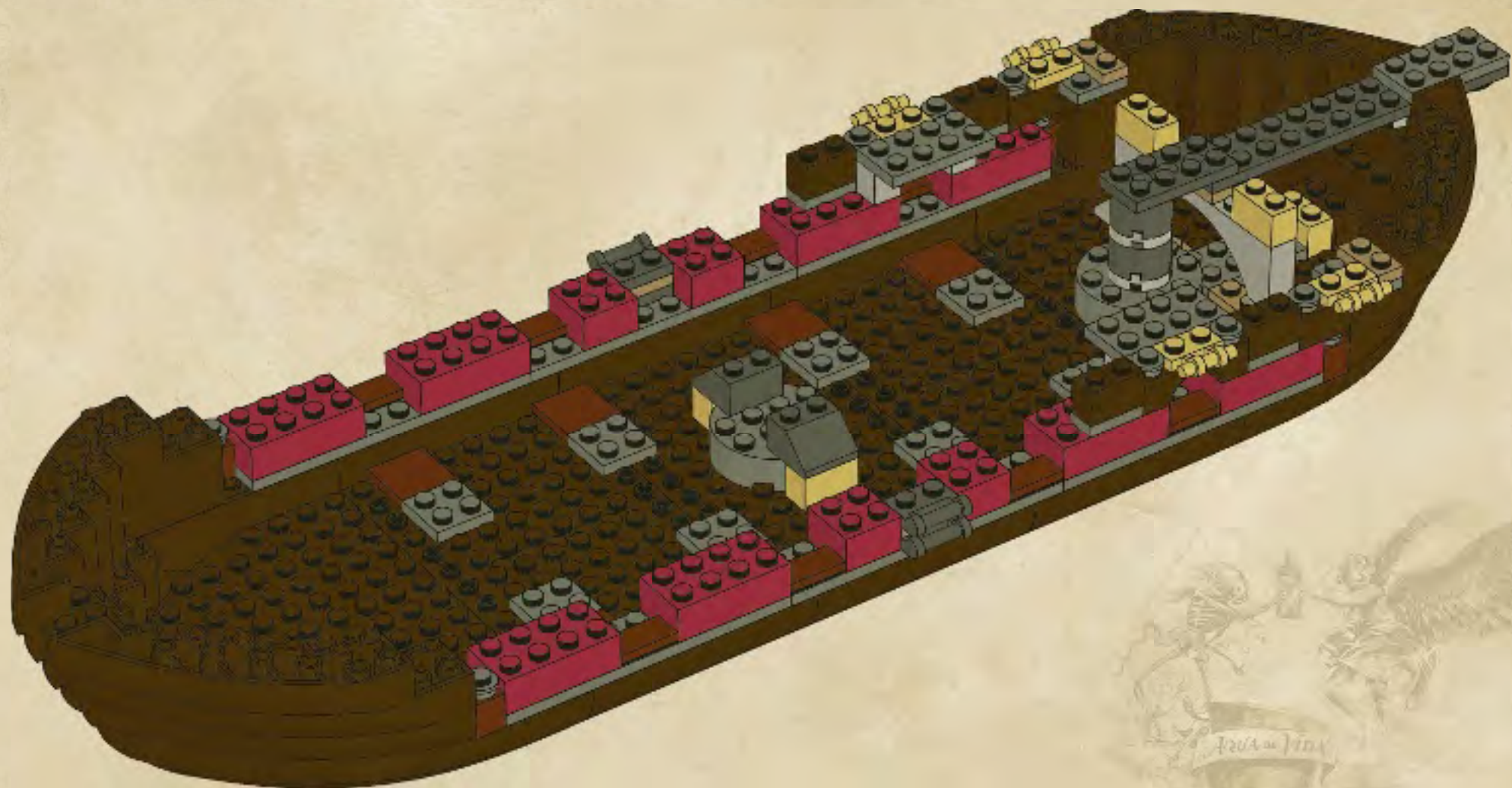

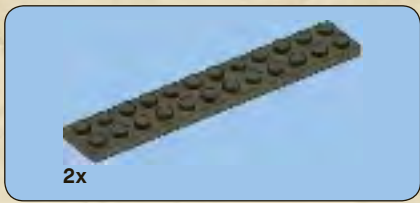

19

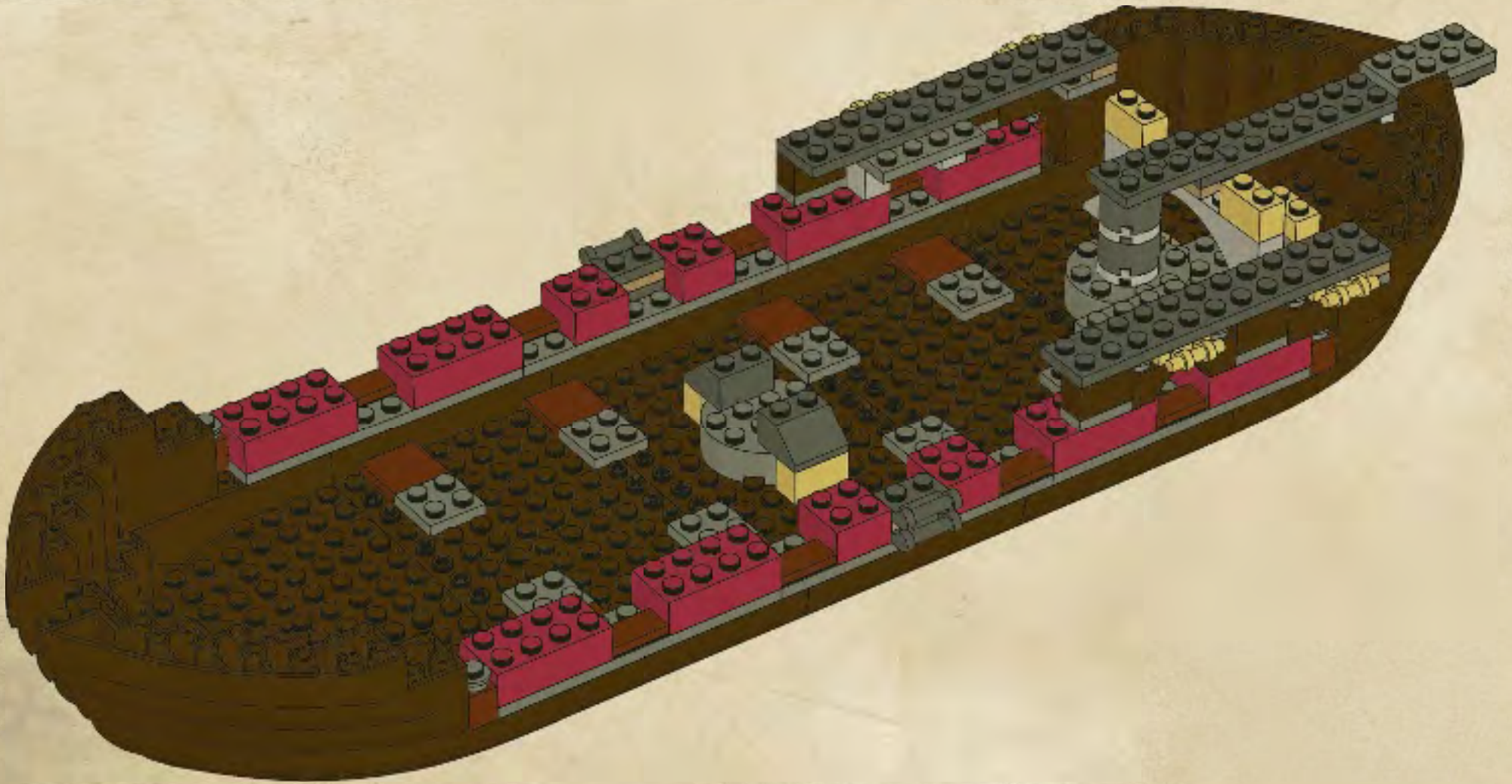

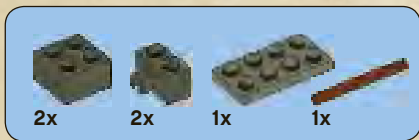

20

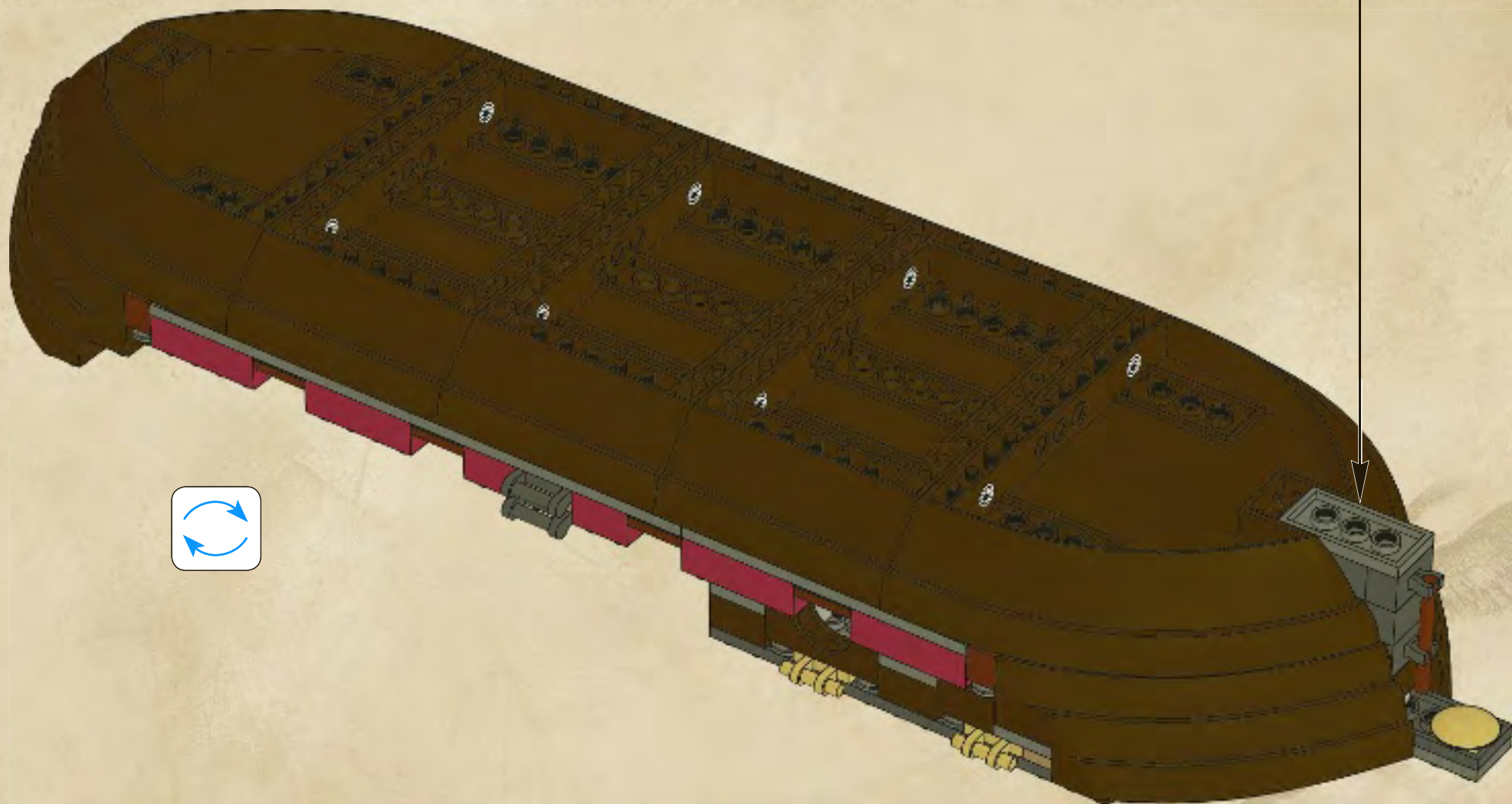

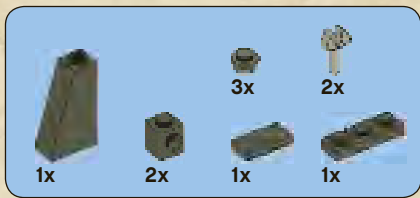

21

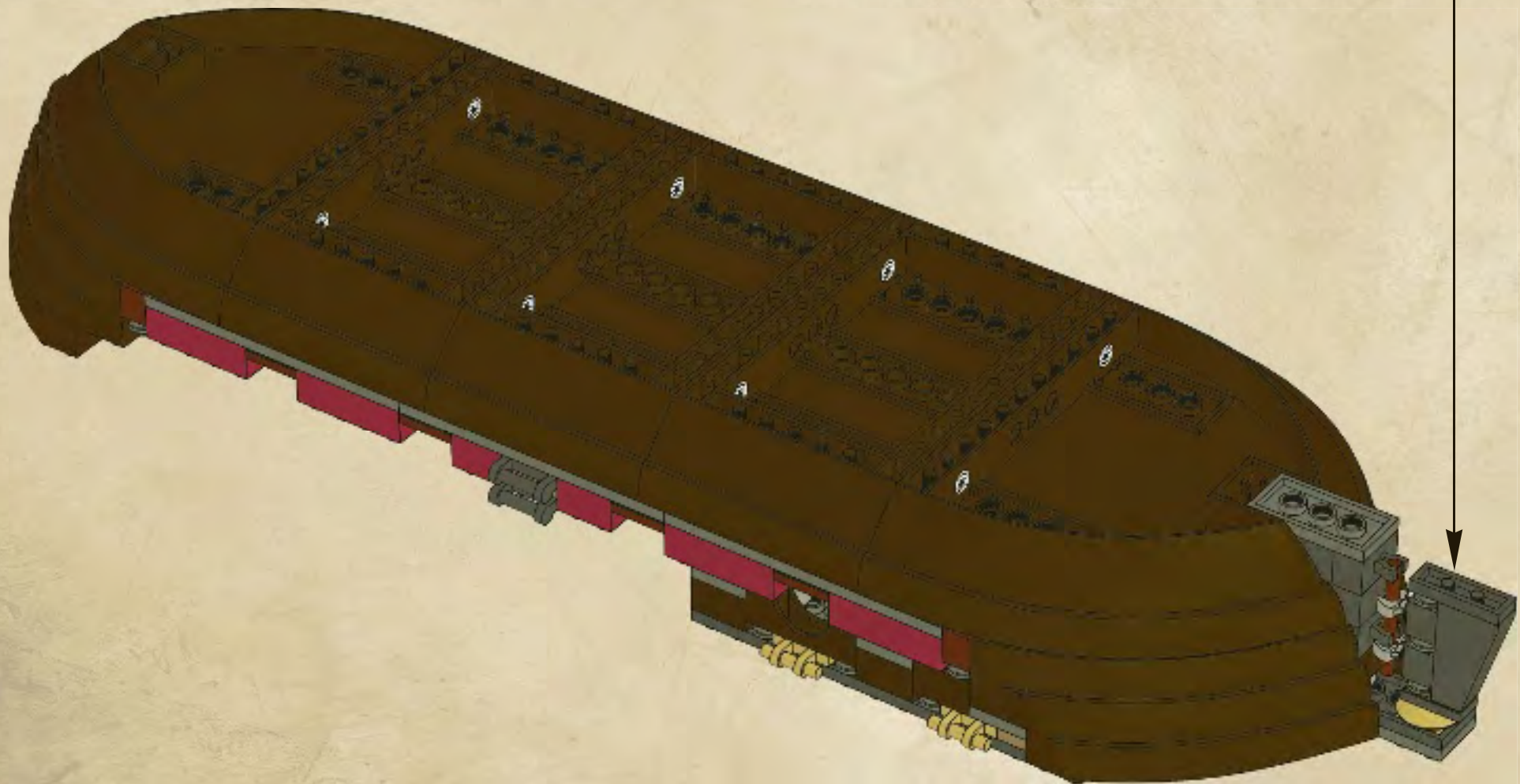

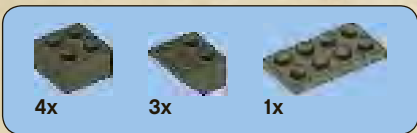

22

1



2

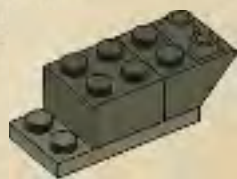

3

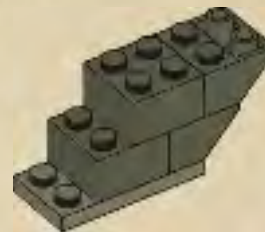

4

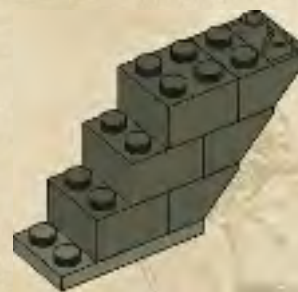

5

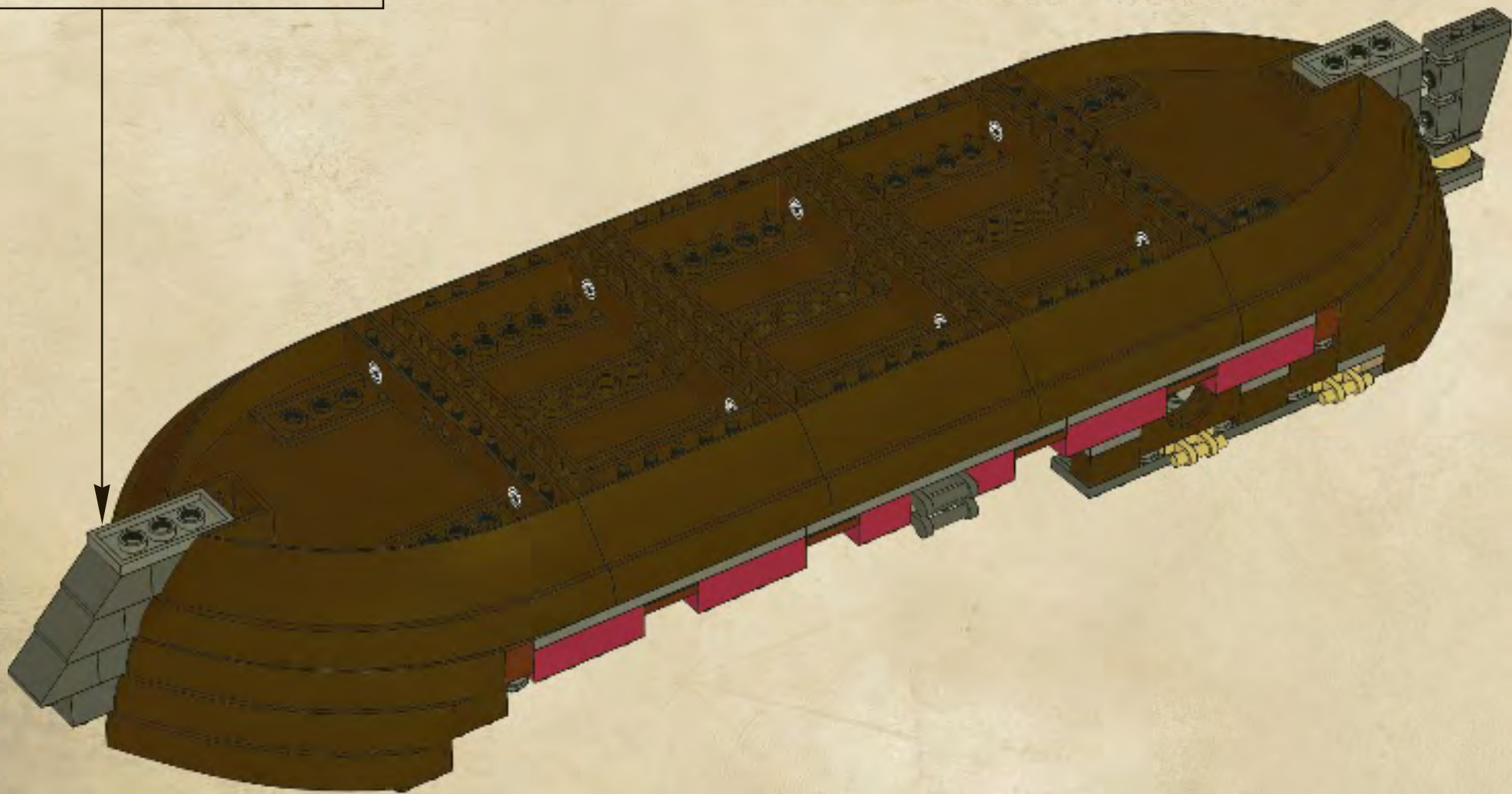
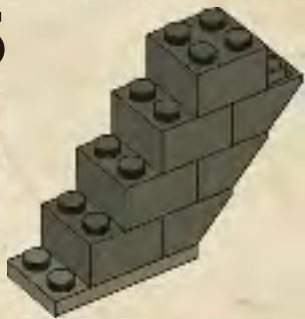

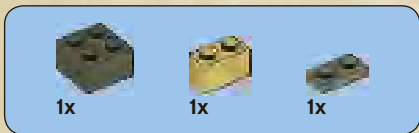

23

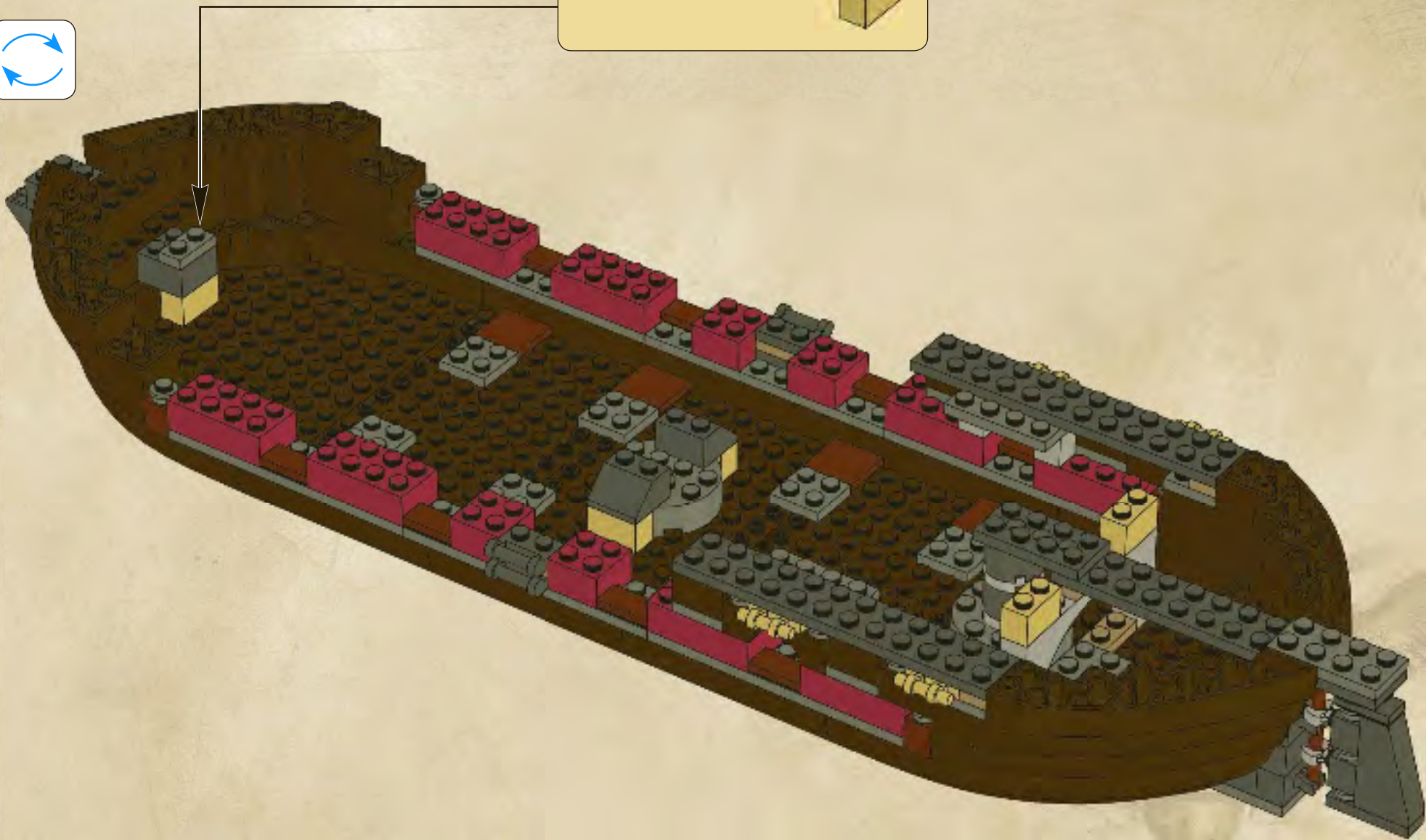
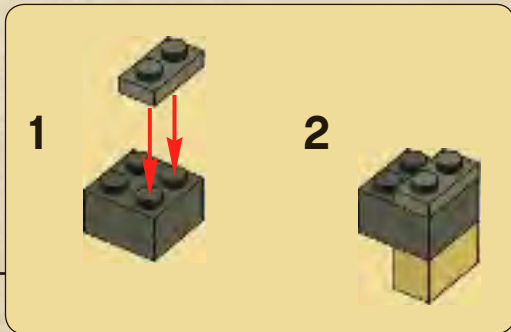

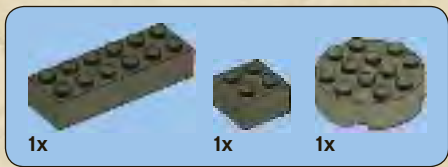

24

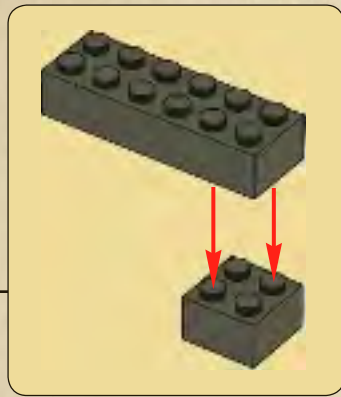

1x 2x 2x

25

1 2 3

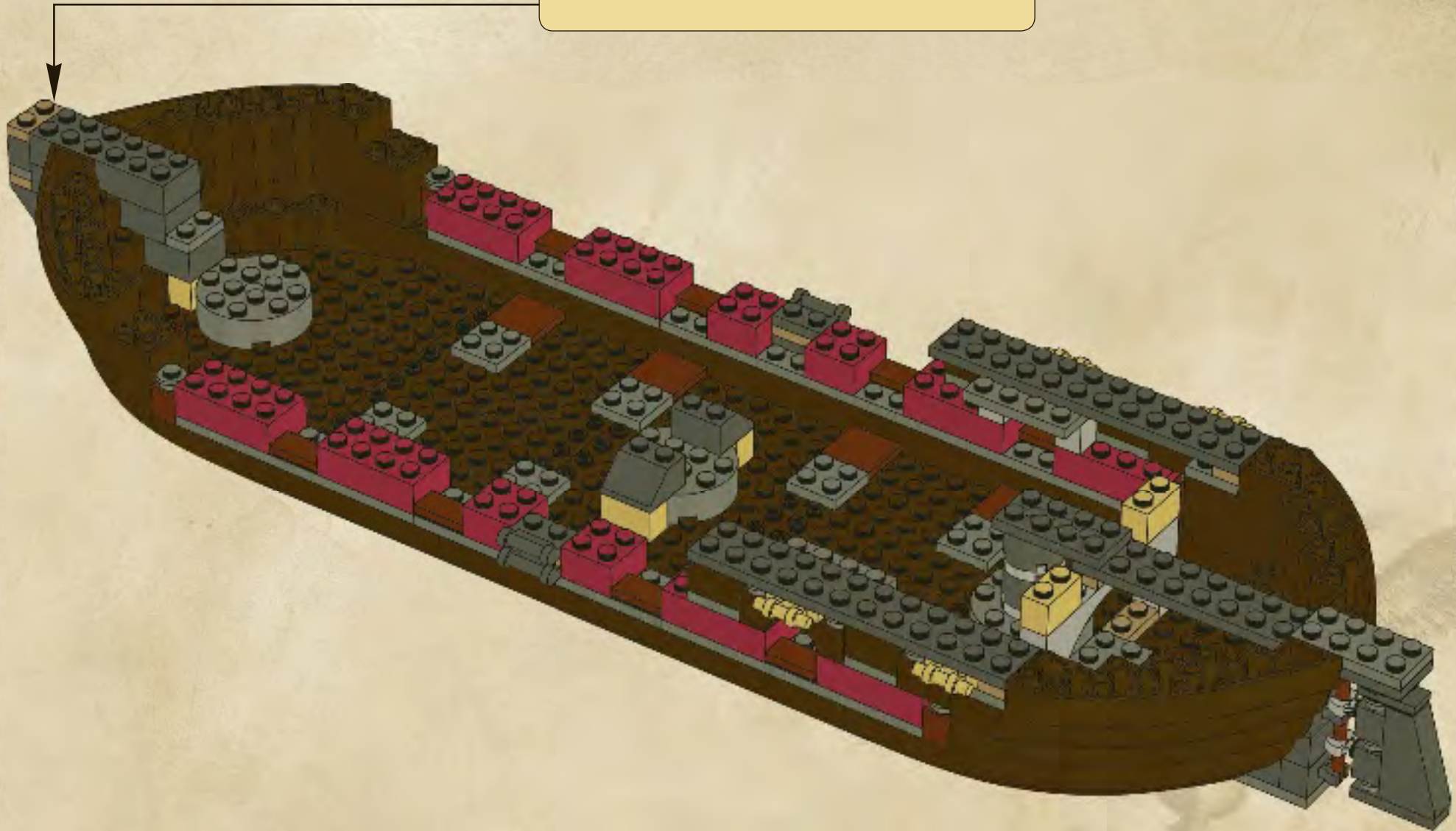

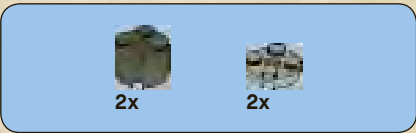

26





27

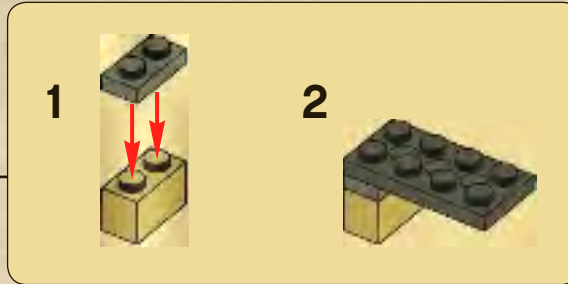

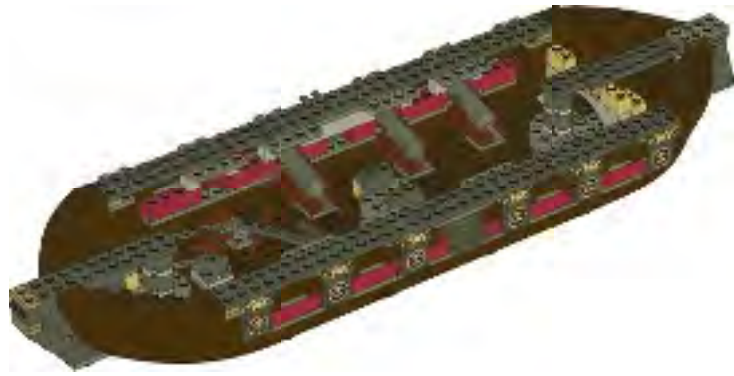

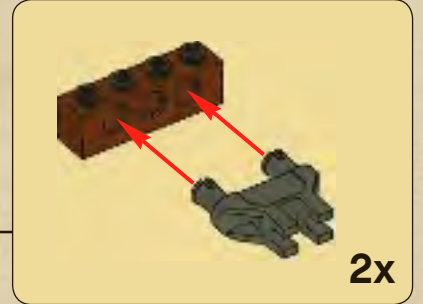
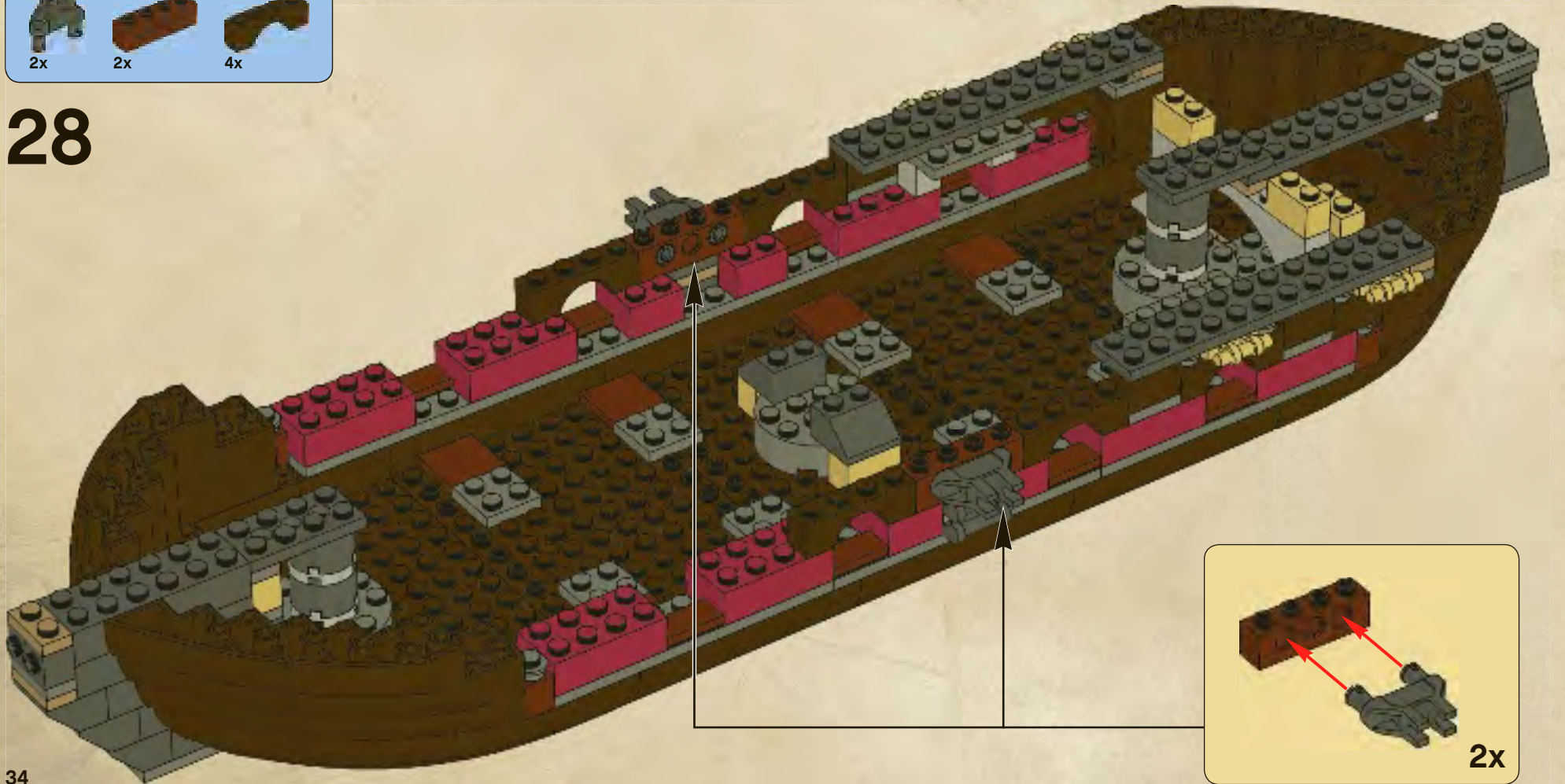

28



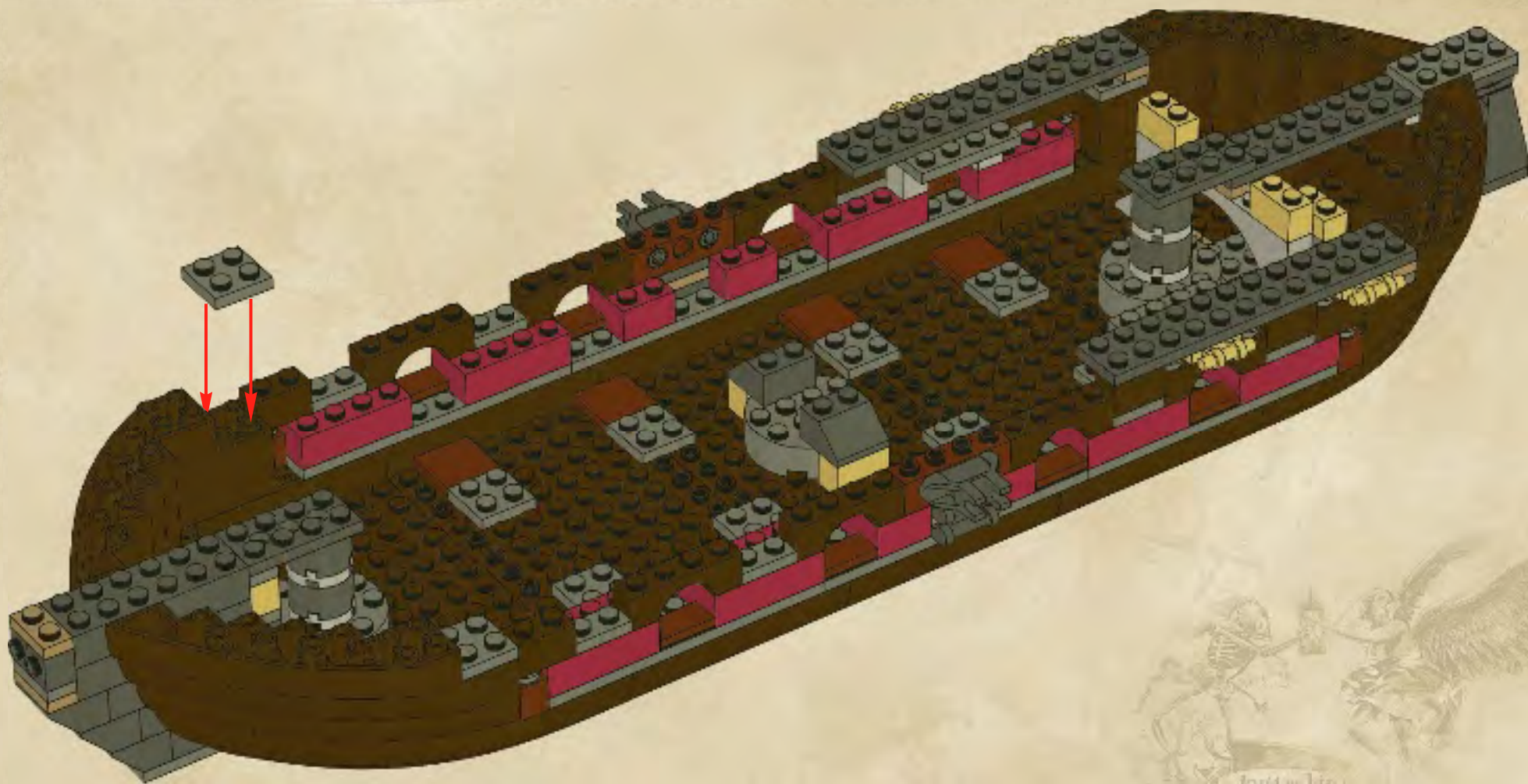

29



8x  2x 

30

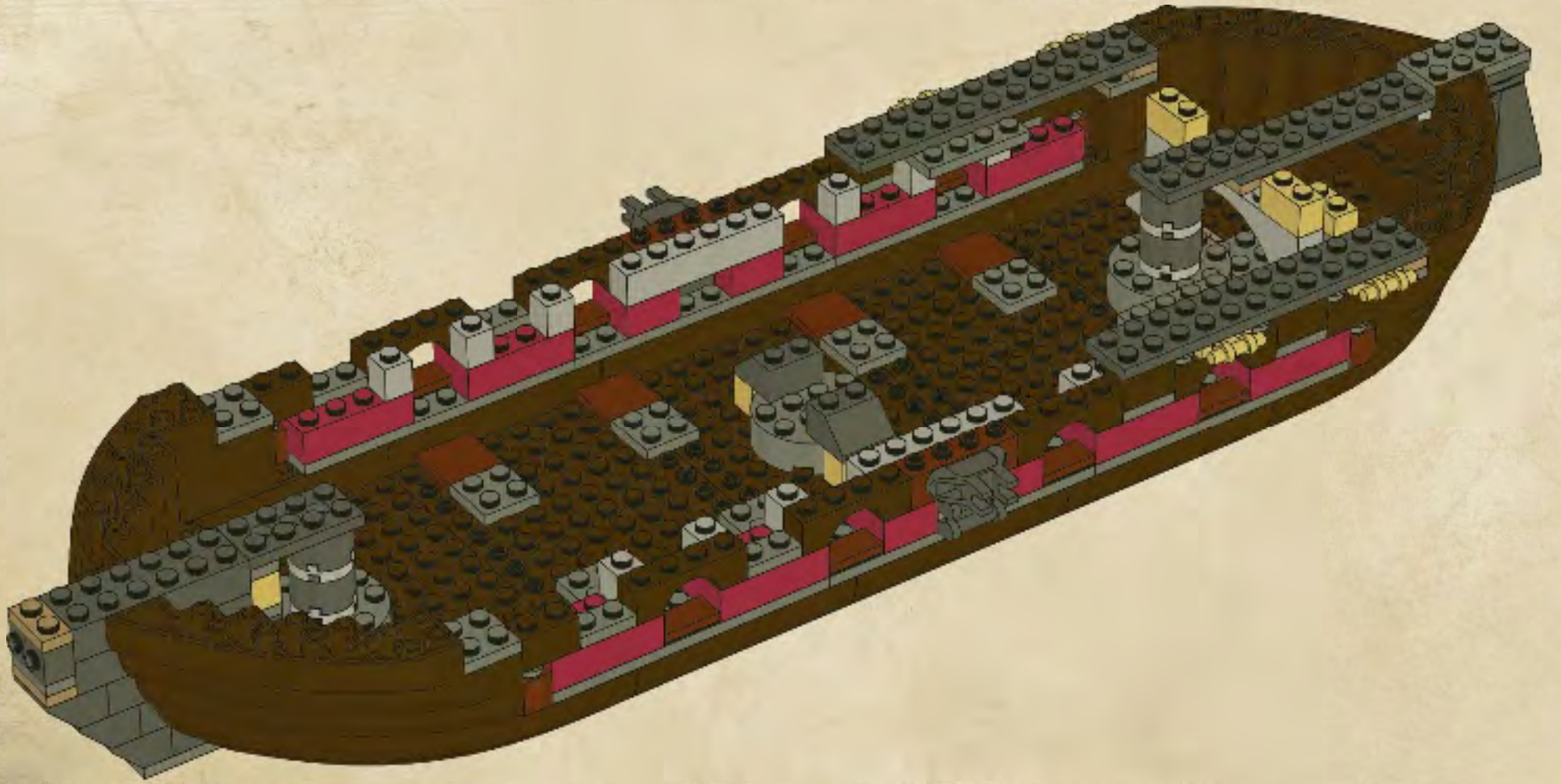

8x 14x 2x

31

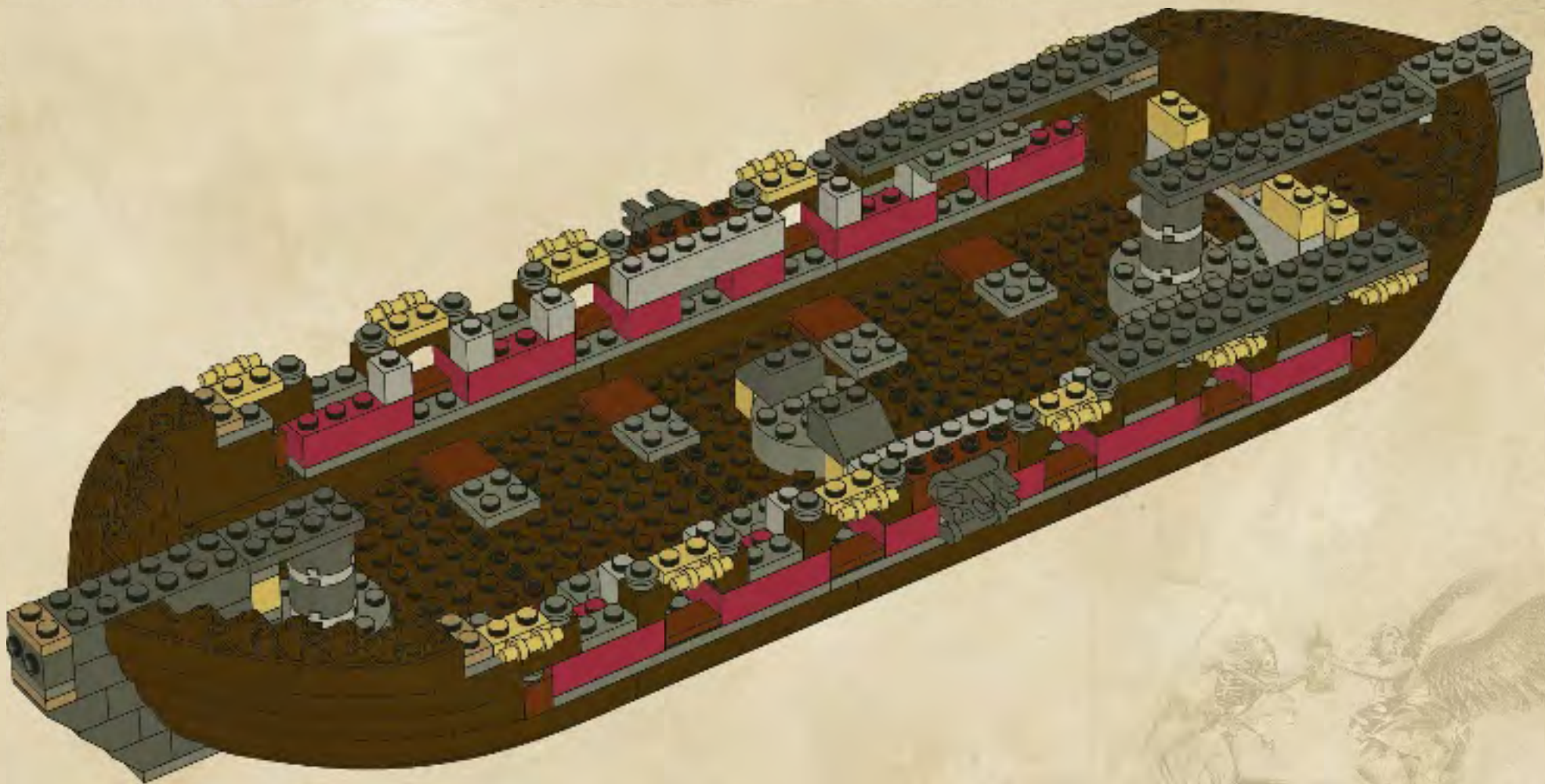

2x  4x 

32

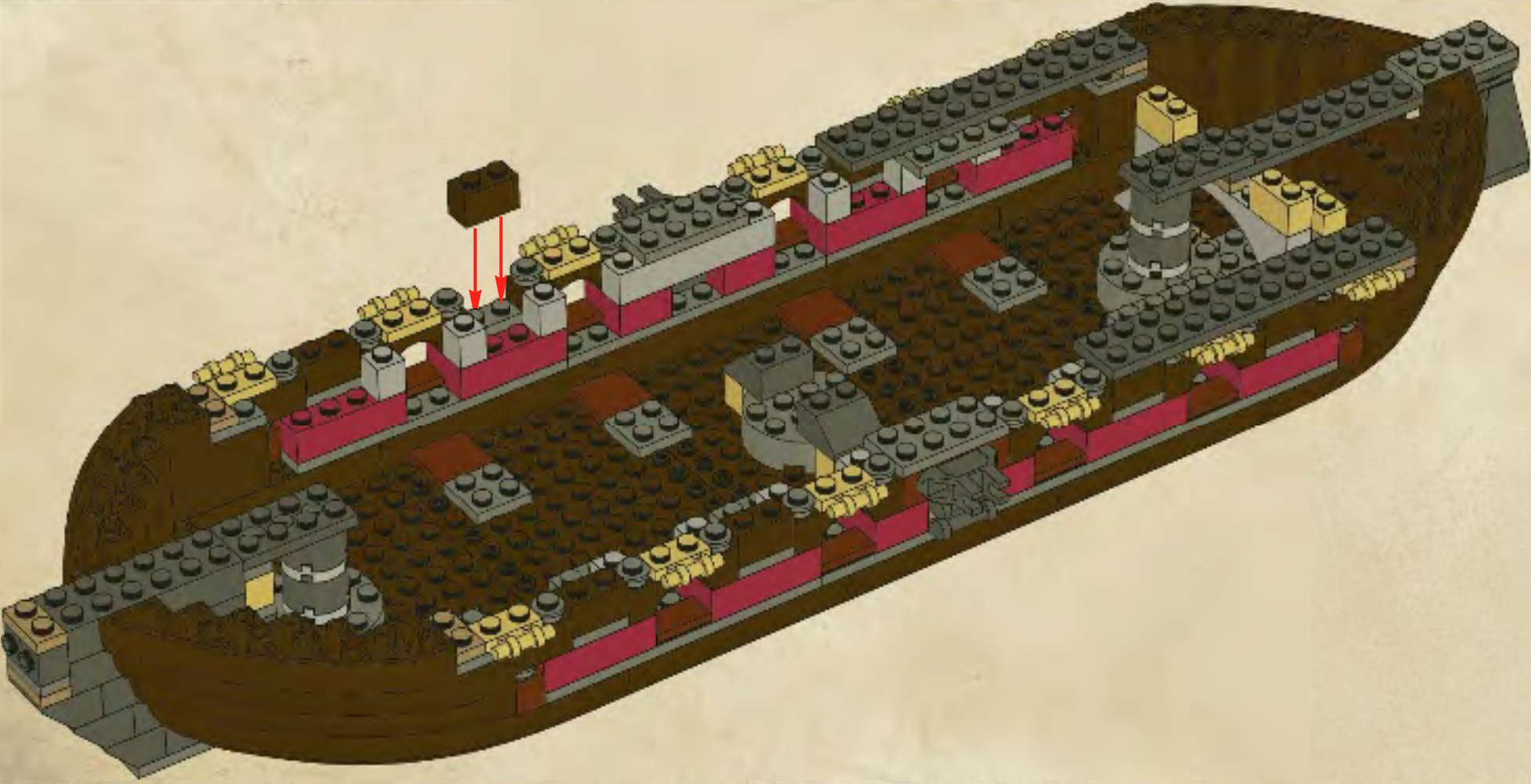



6x

33

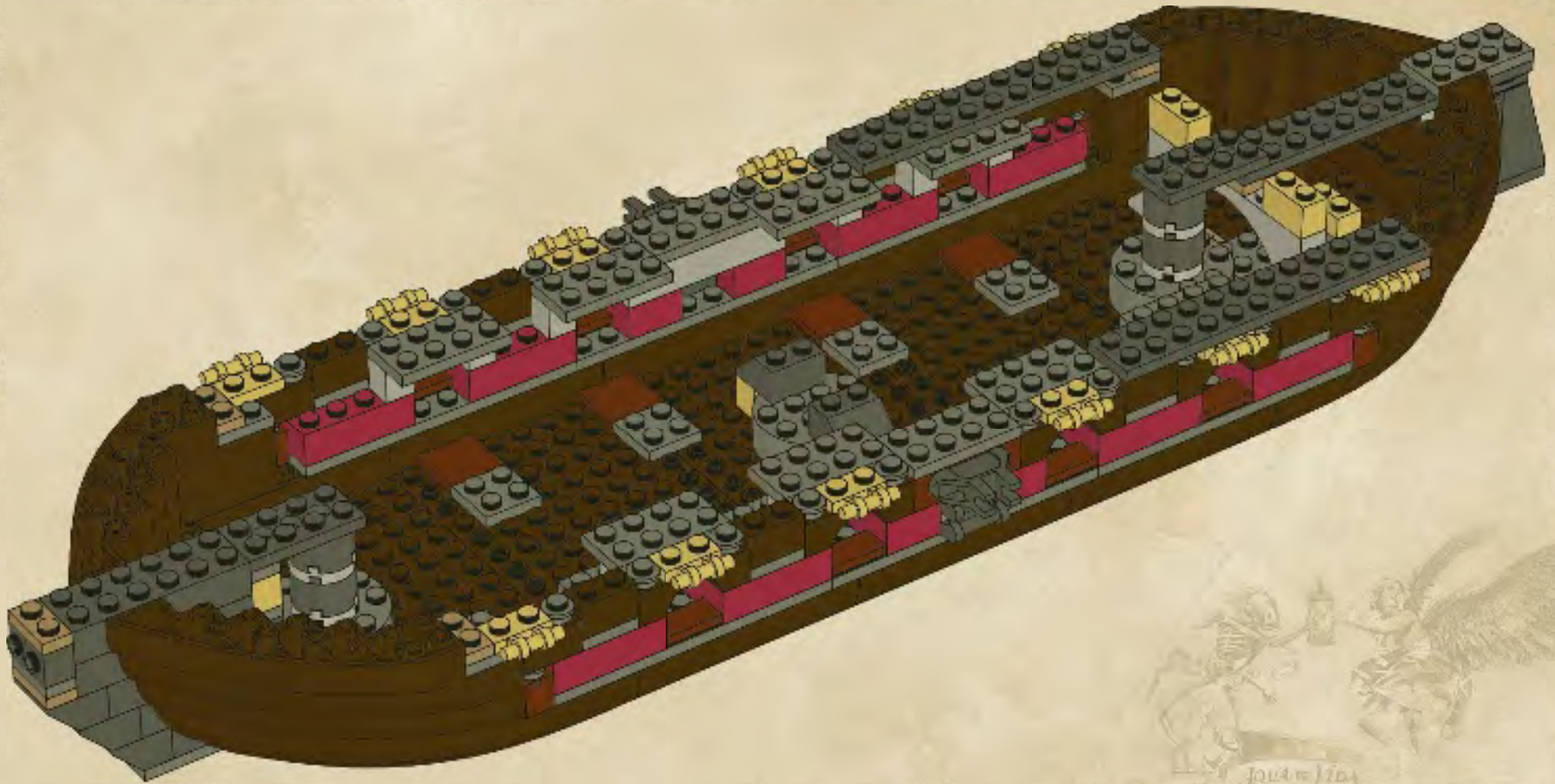

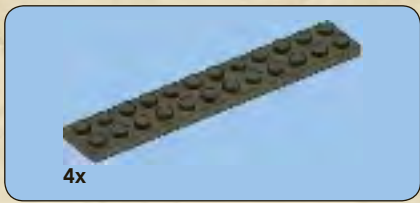

34

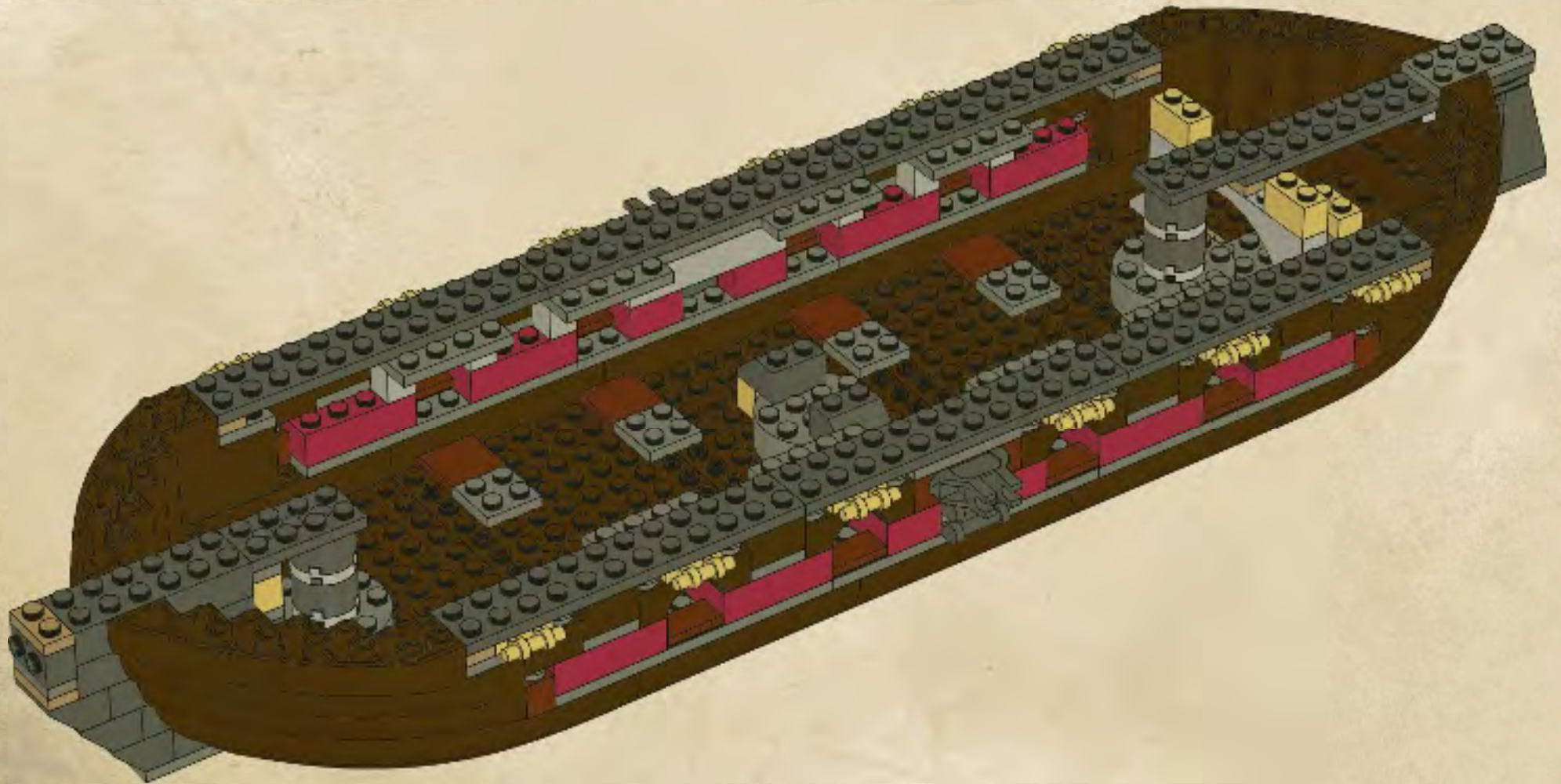



35

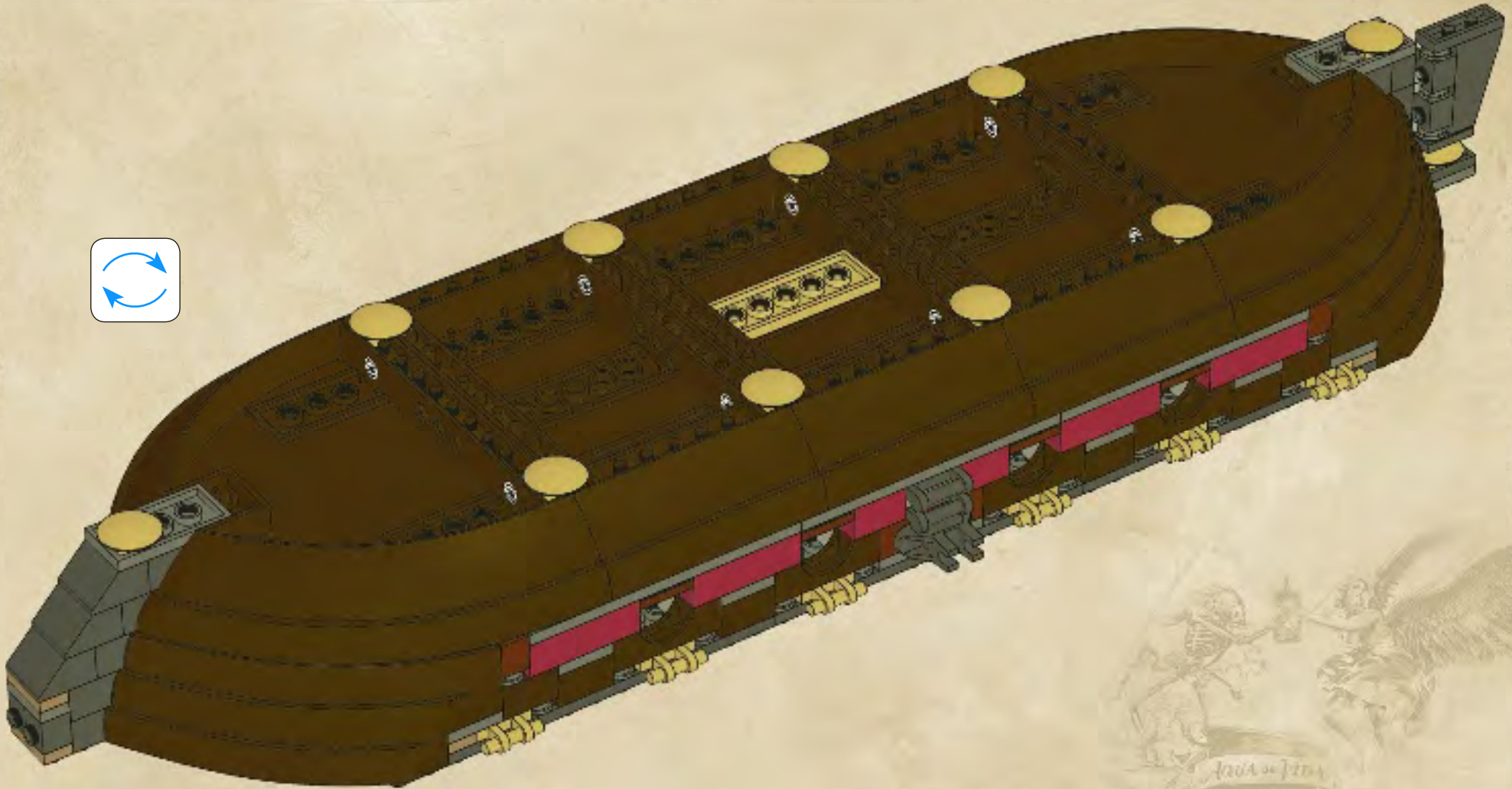

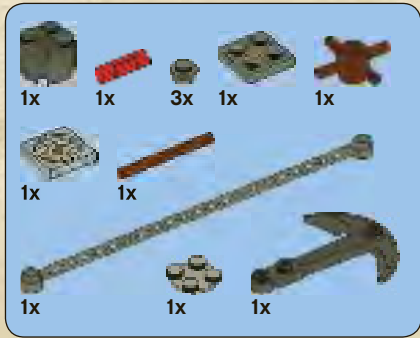
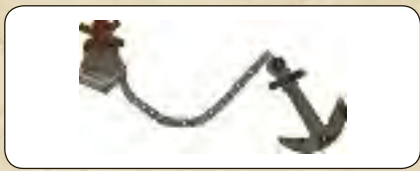

36

1



2



3



4

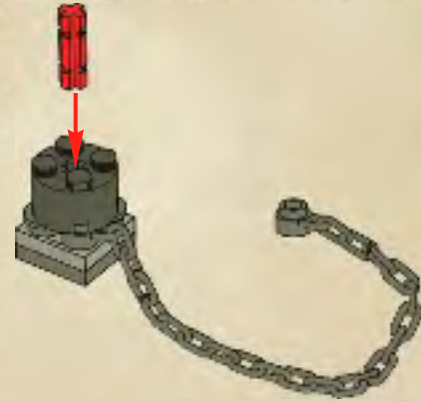

5



6

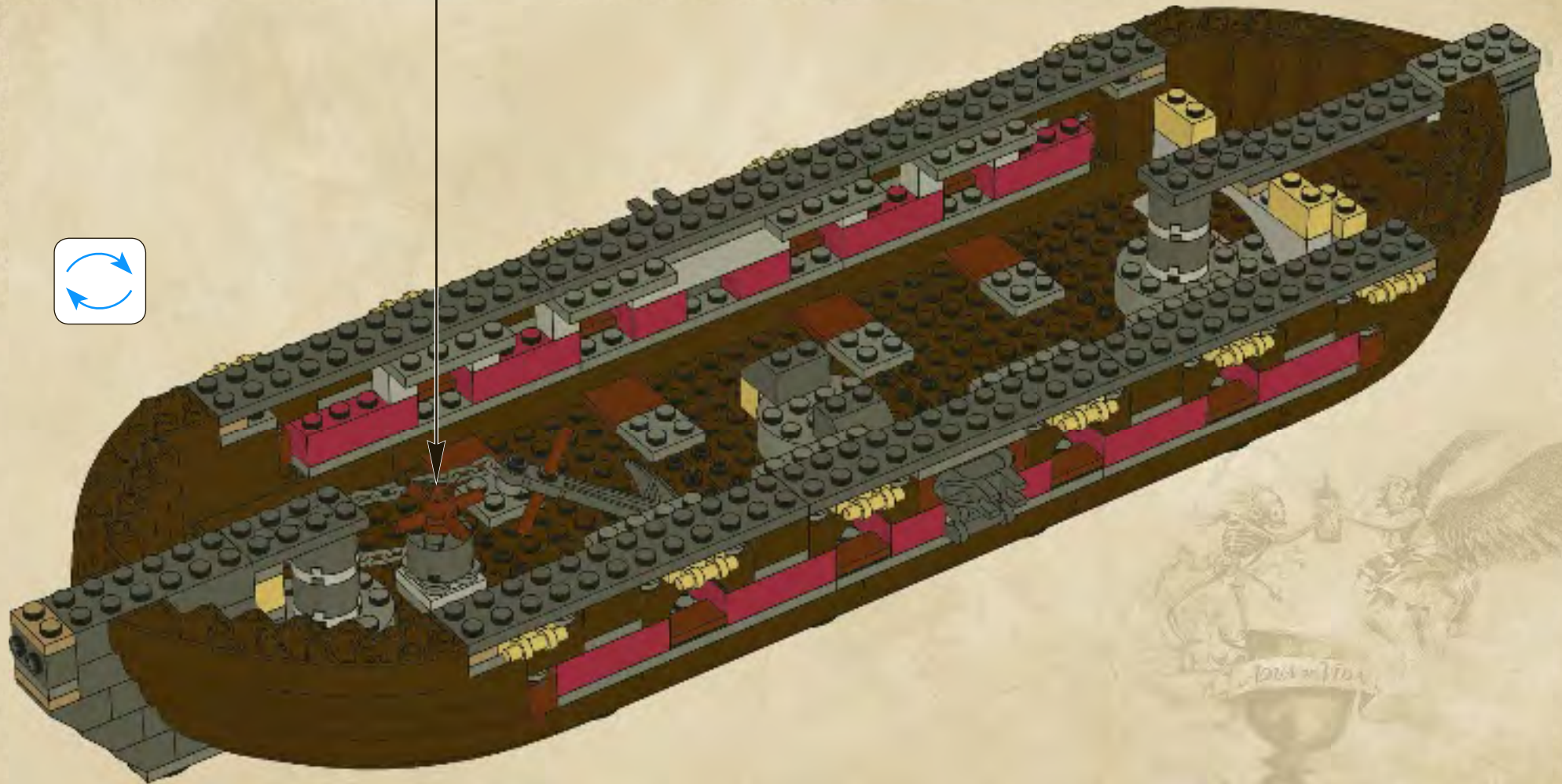



37

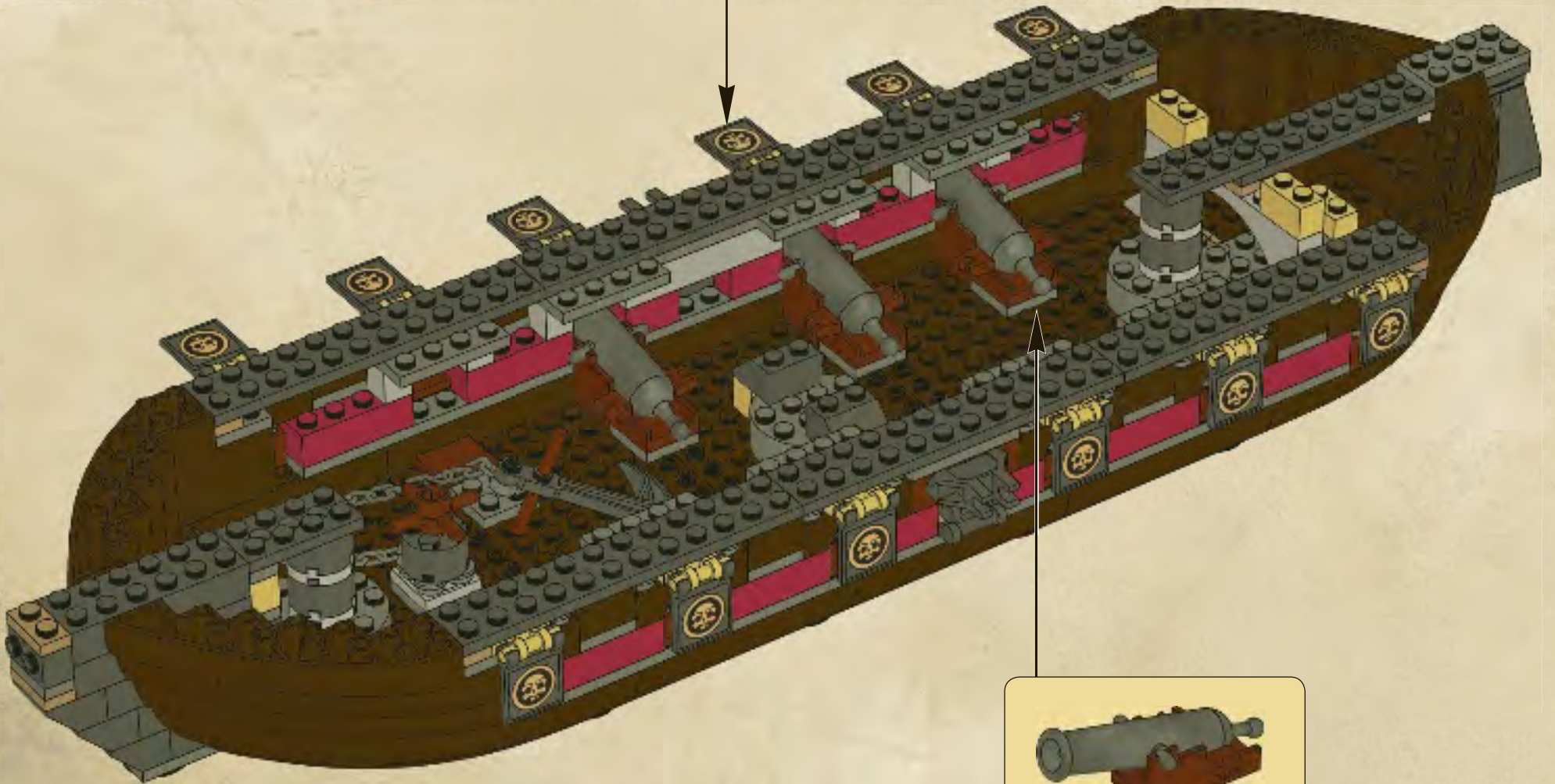

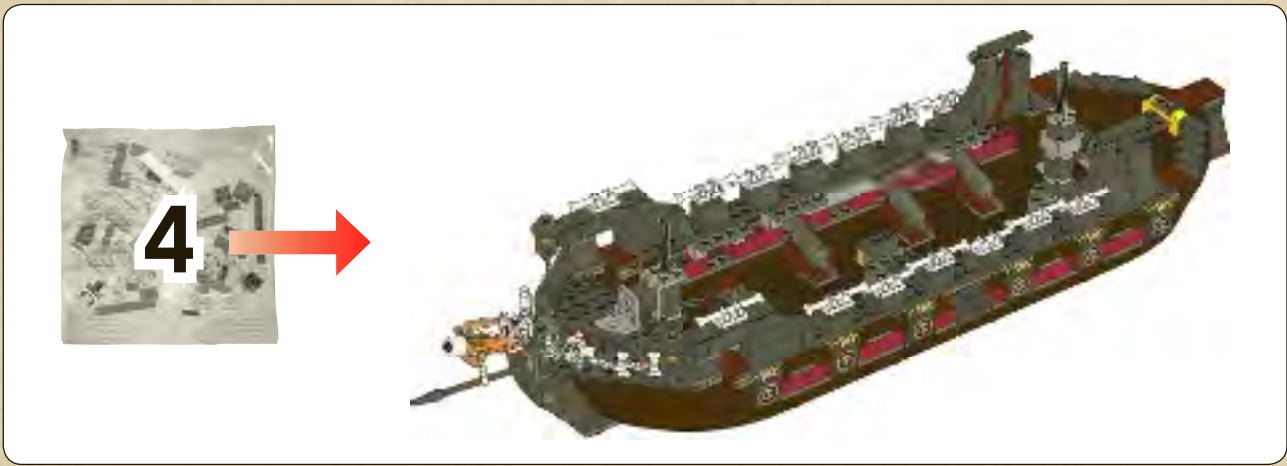

38

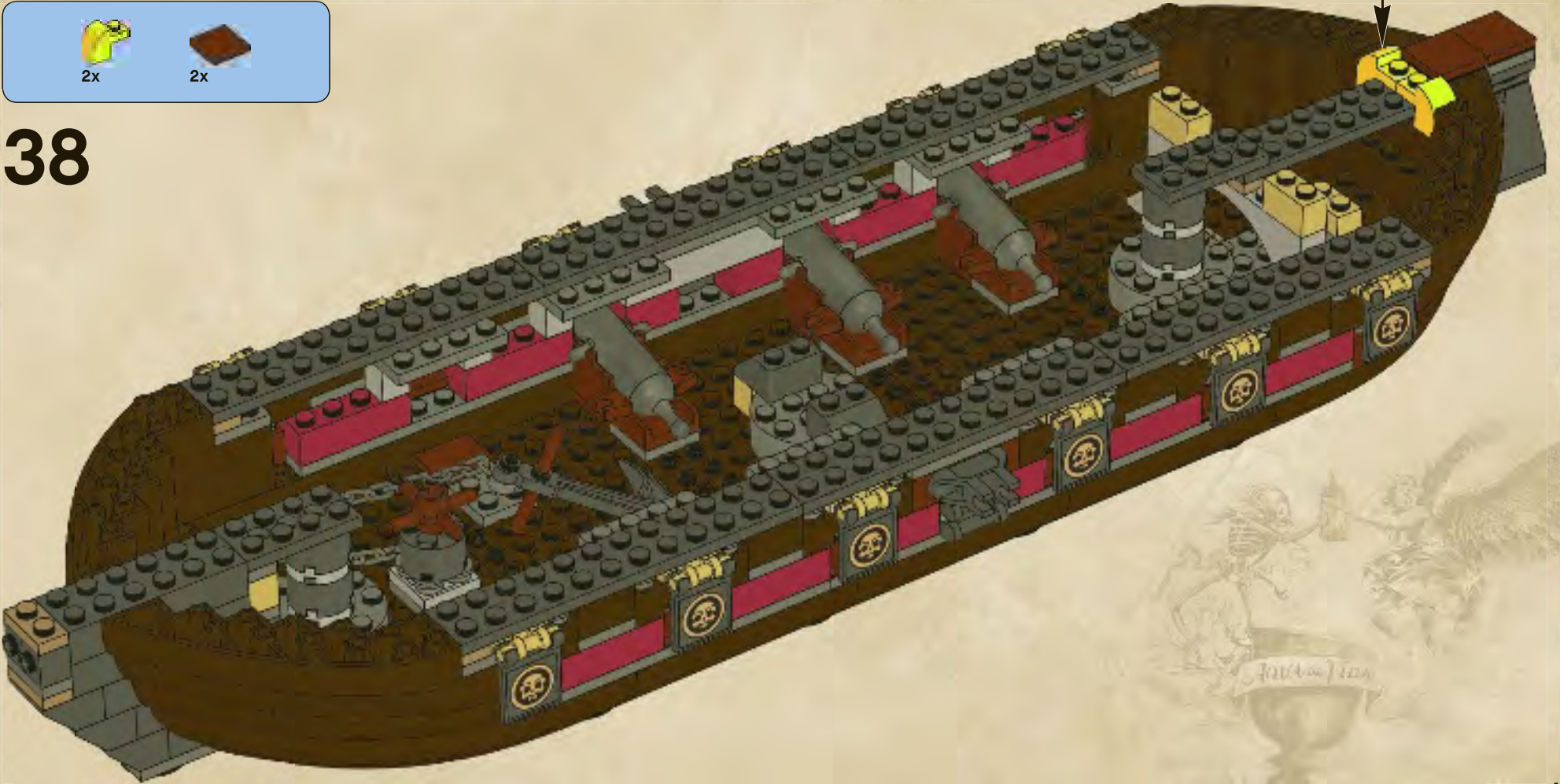

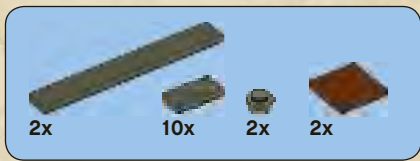

39

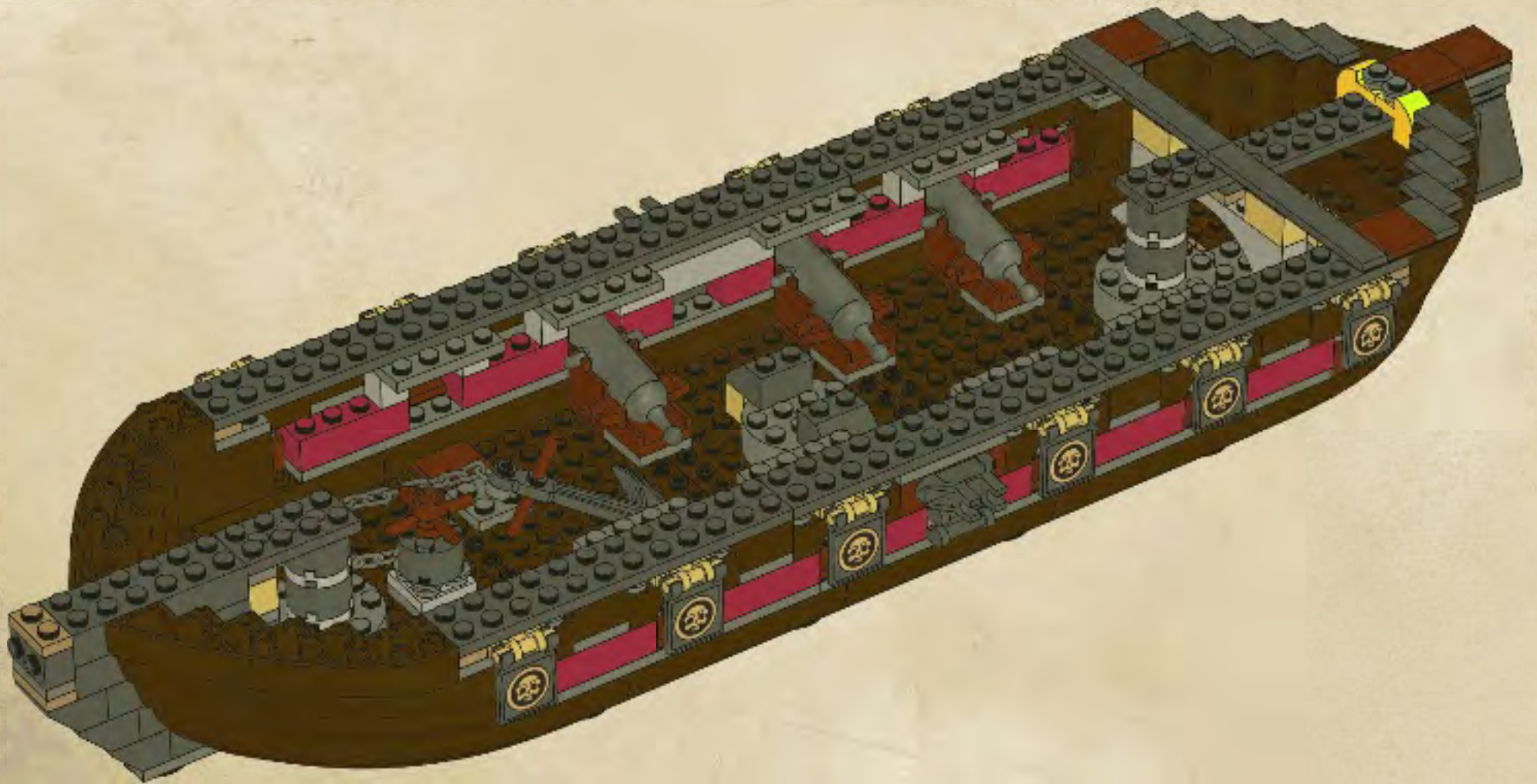

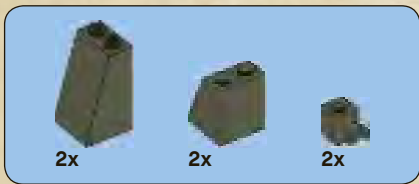

40

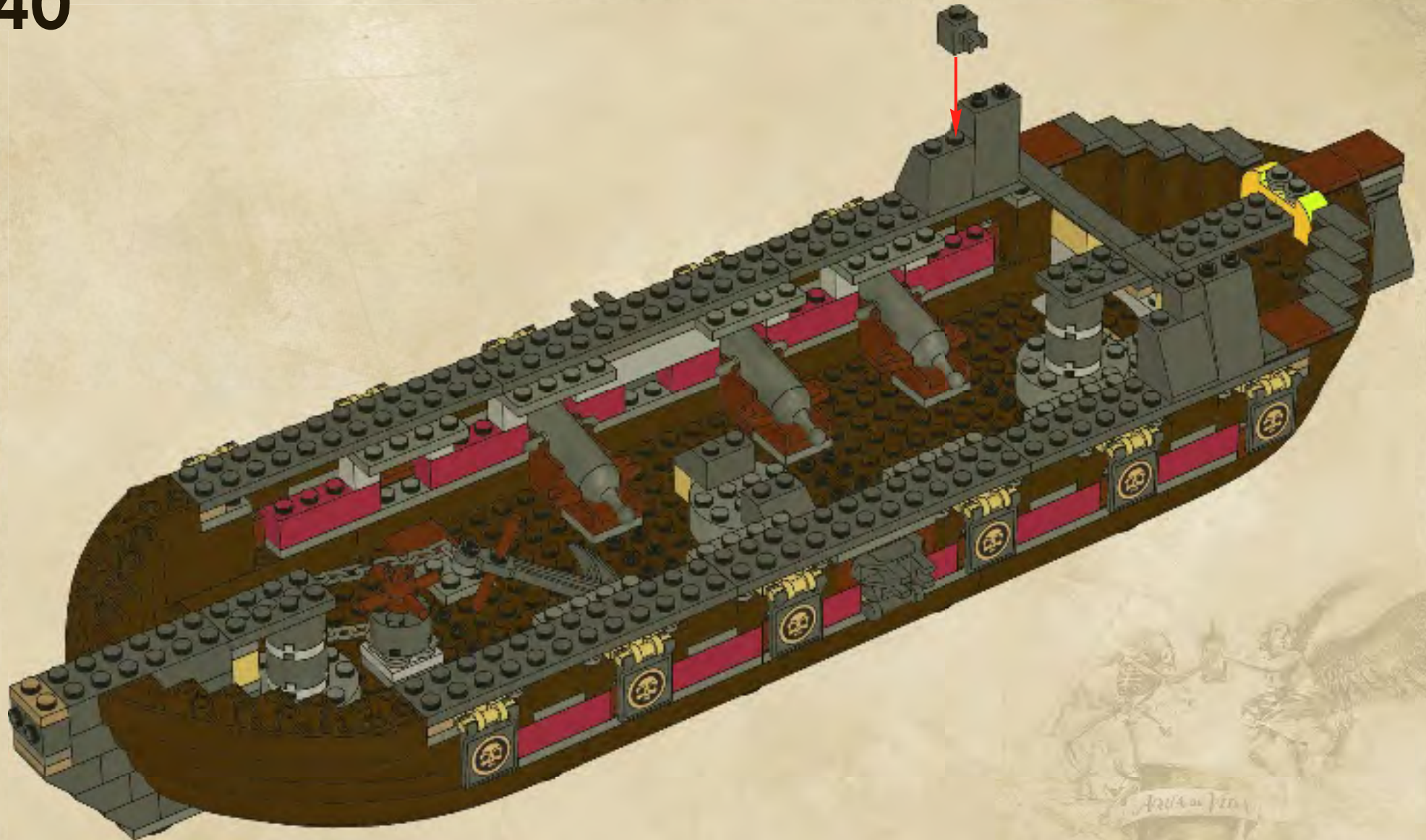

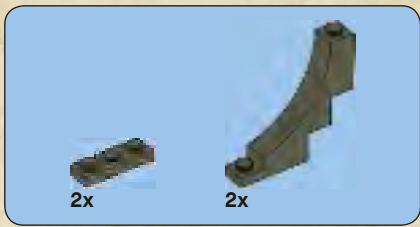

41

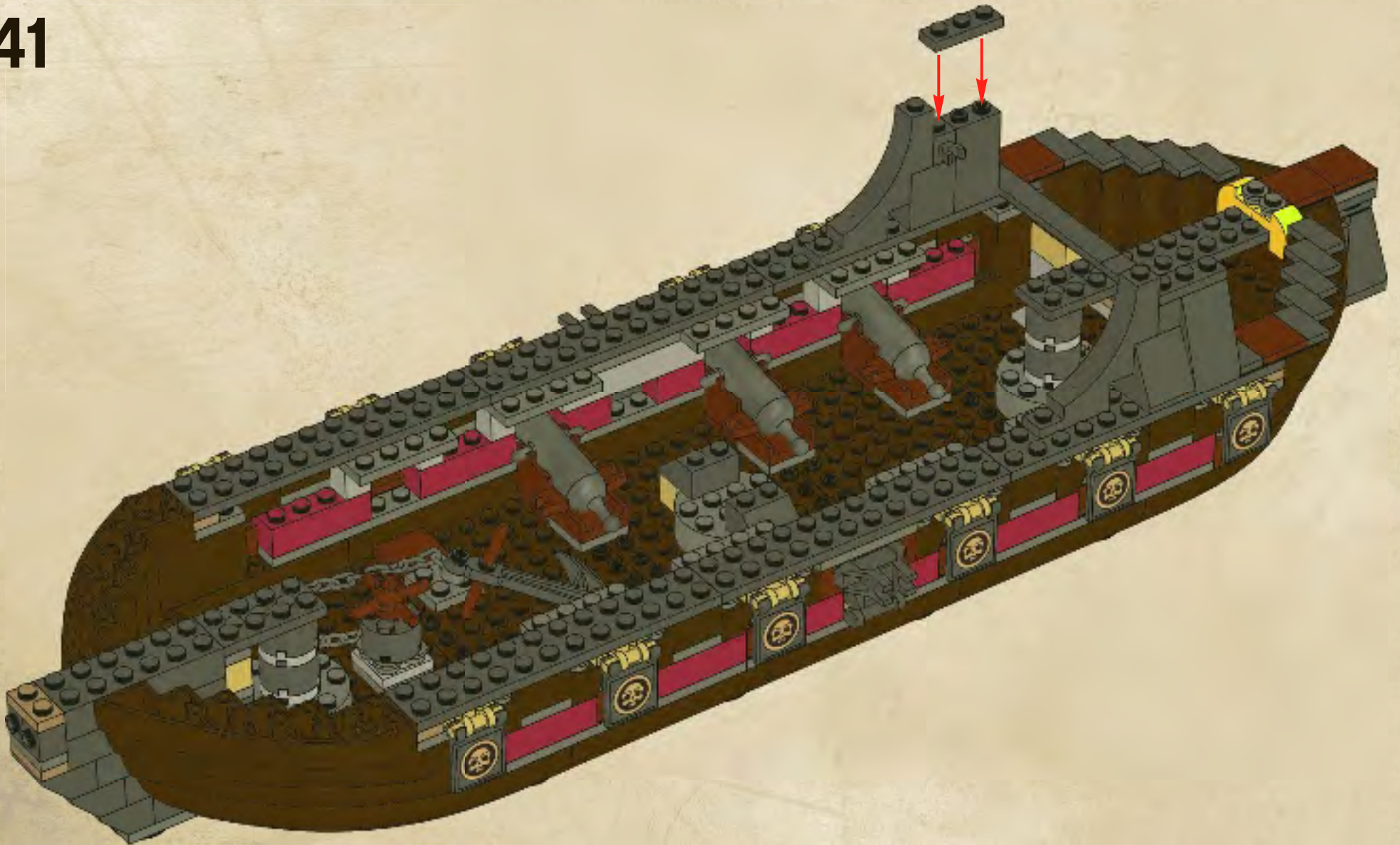

2x 2x 2x

42

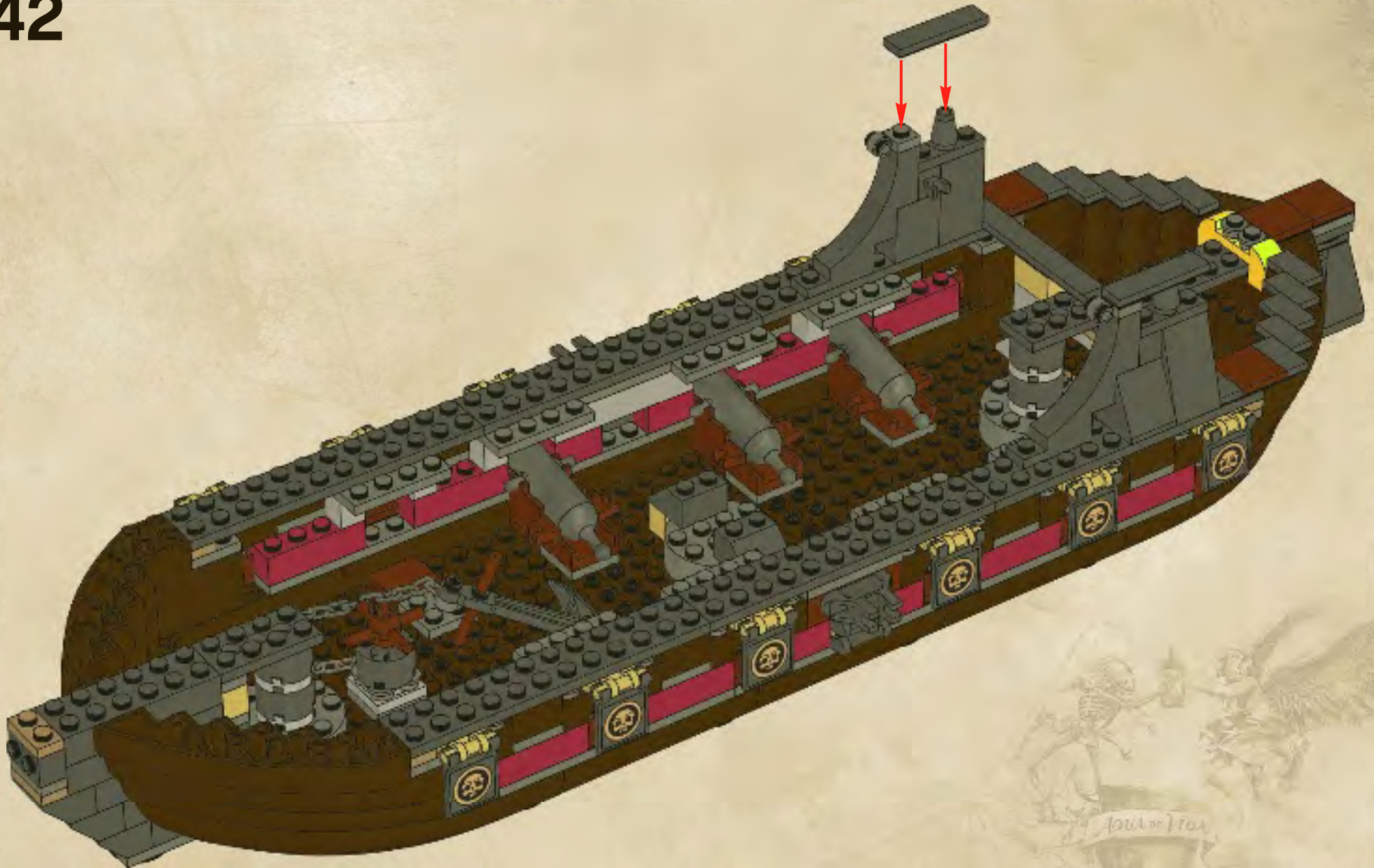

4x 2x 2x

43

1 2 2x

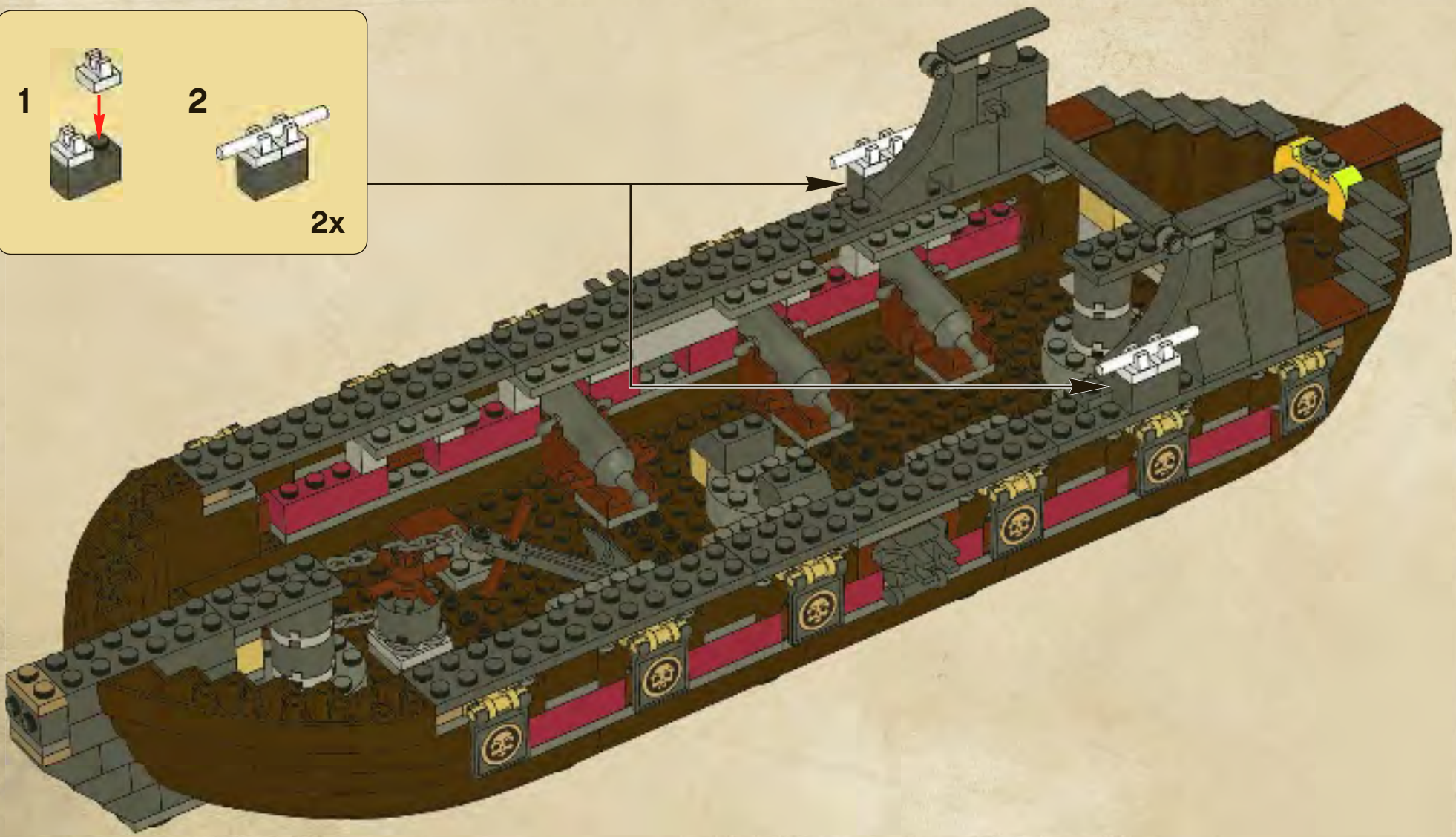



44

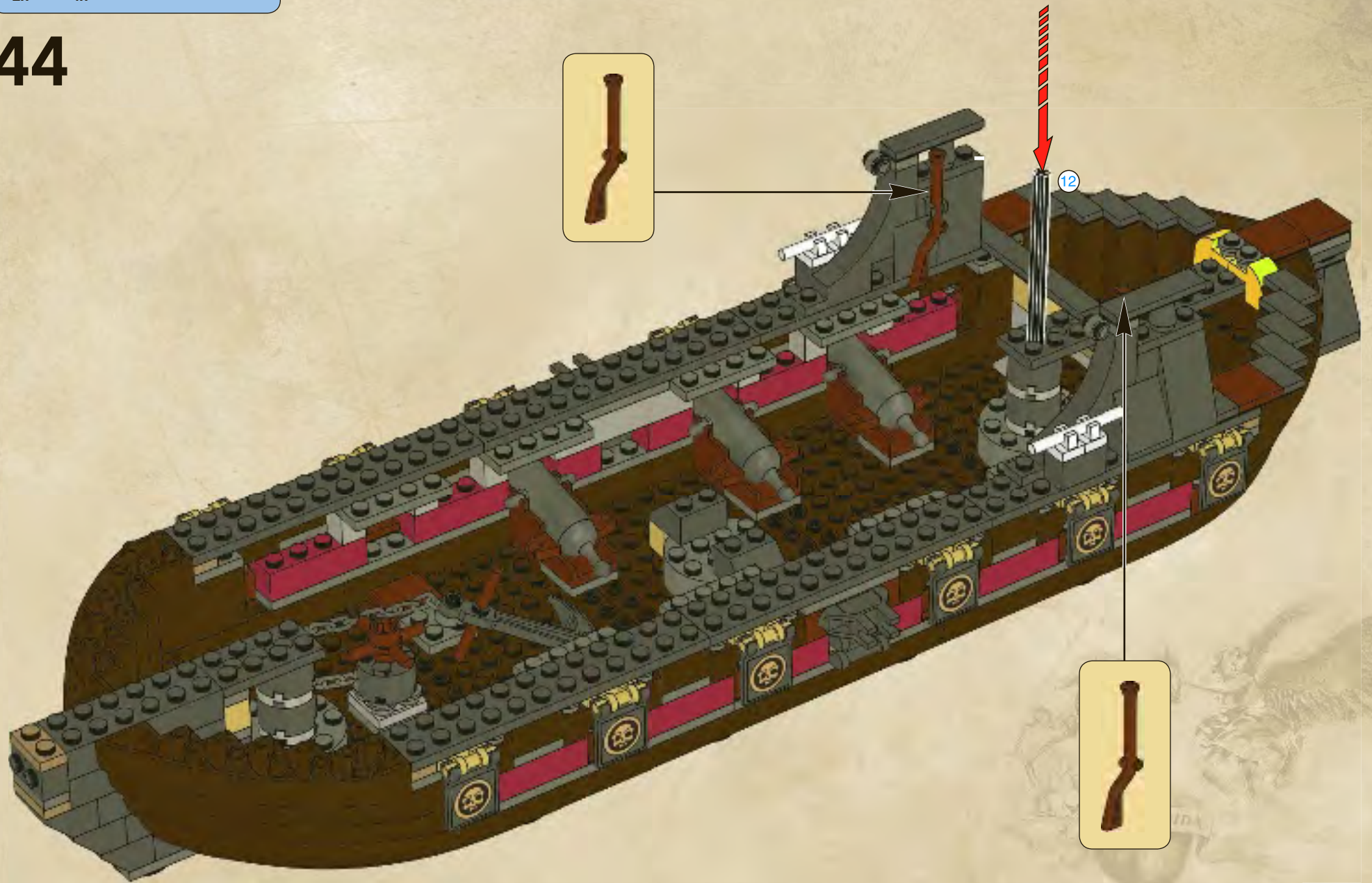



1x



1x

45





1x



1x

46

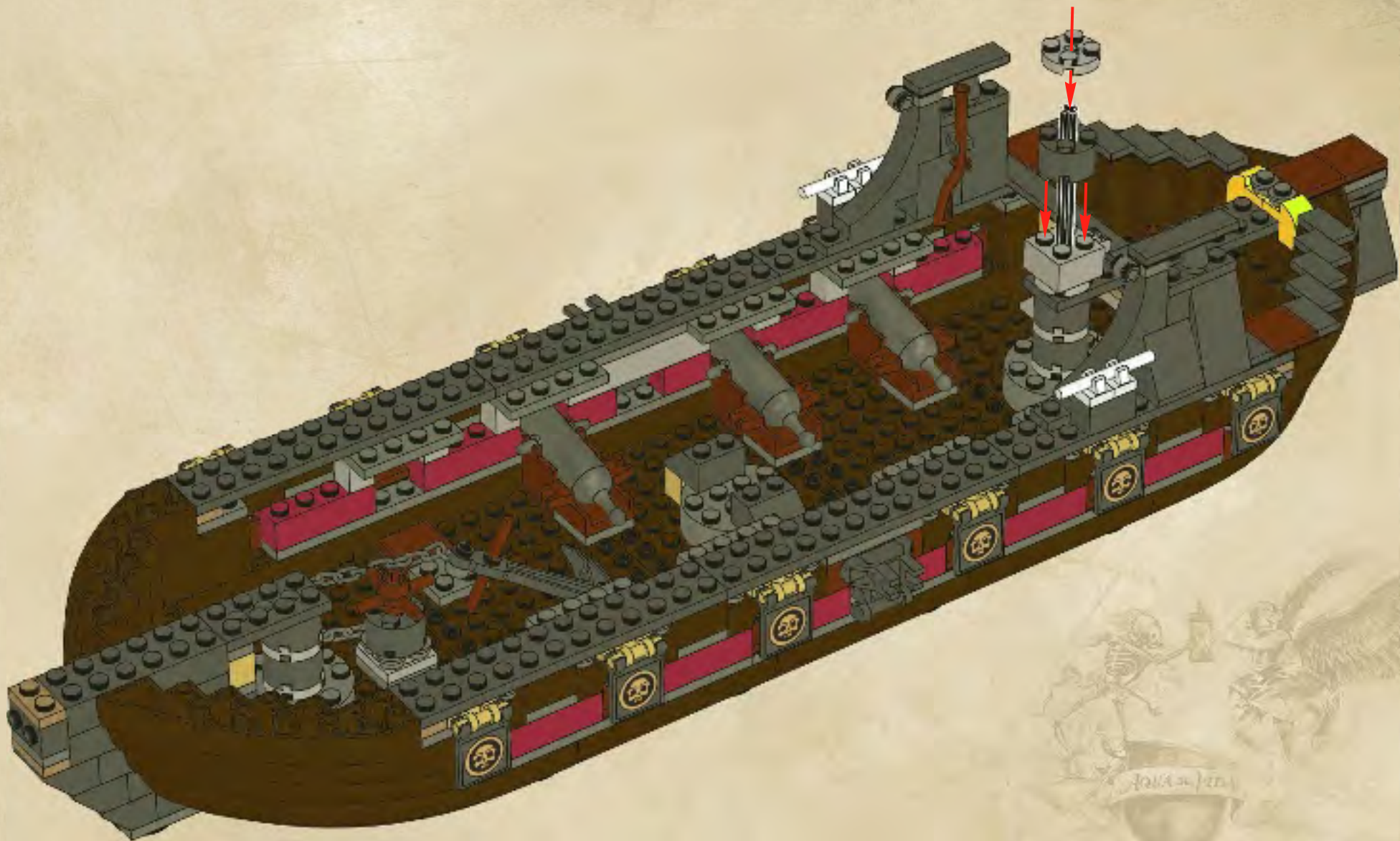



47

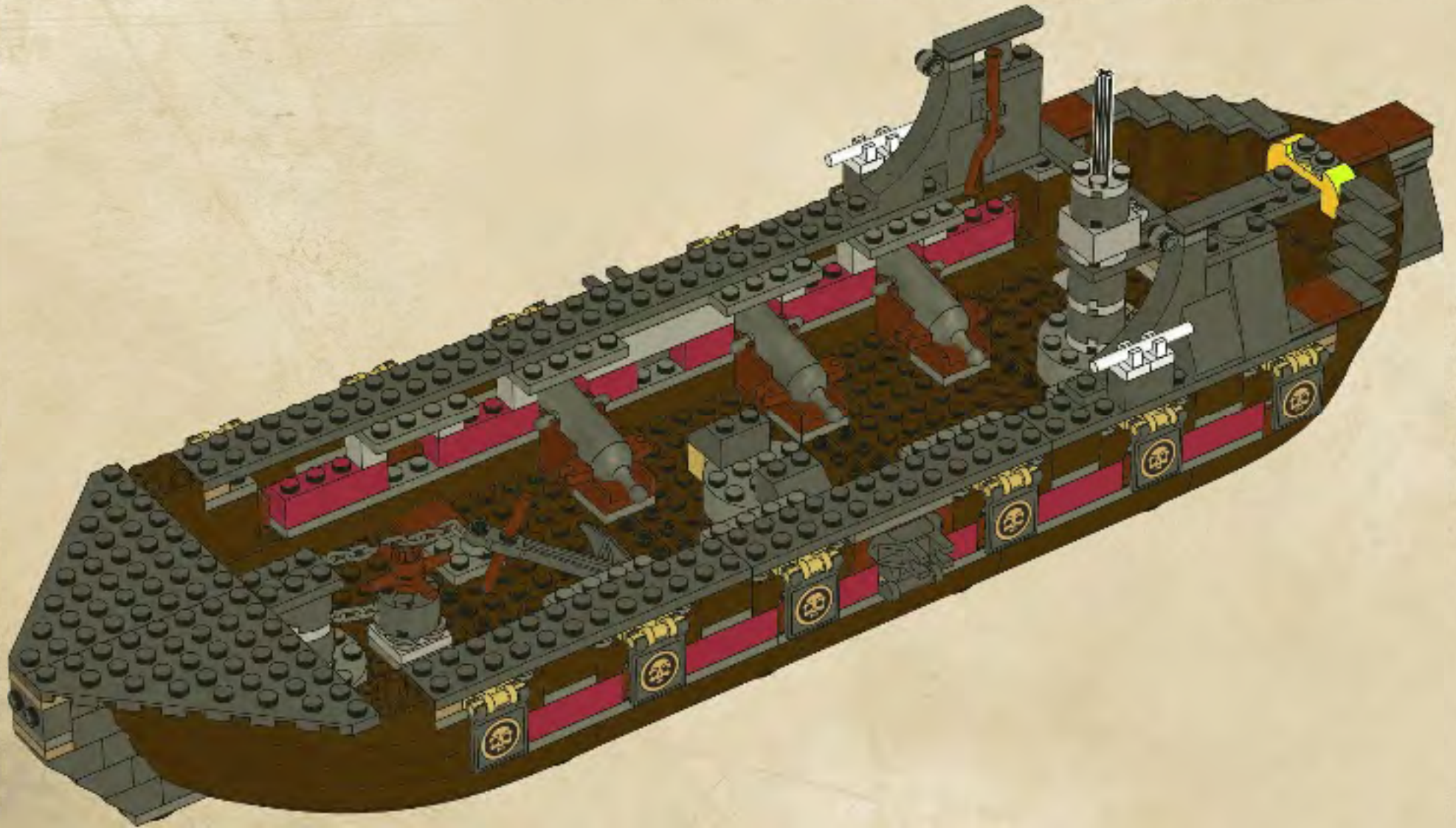



48

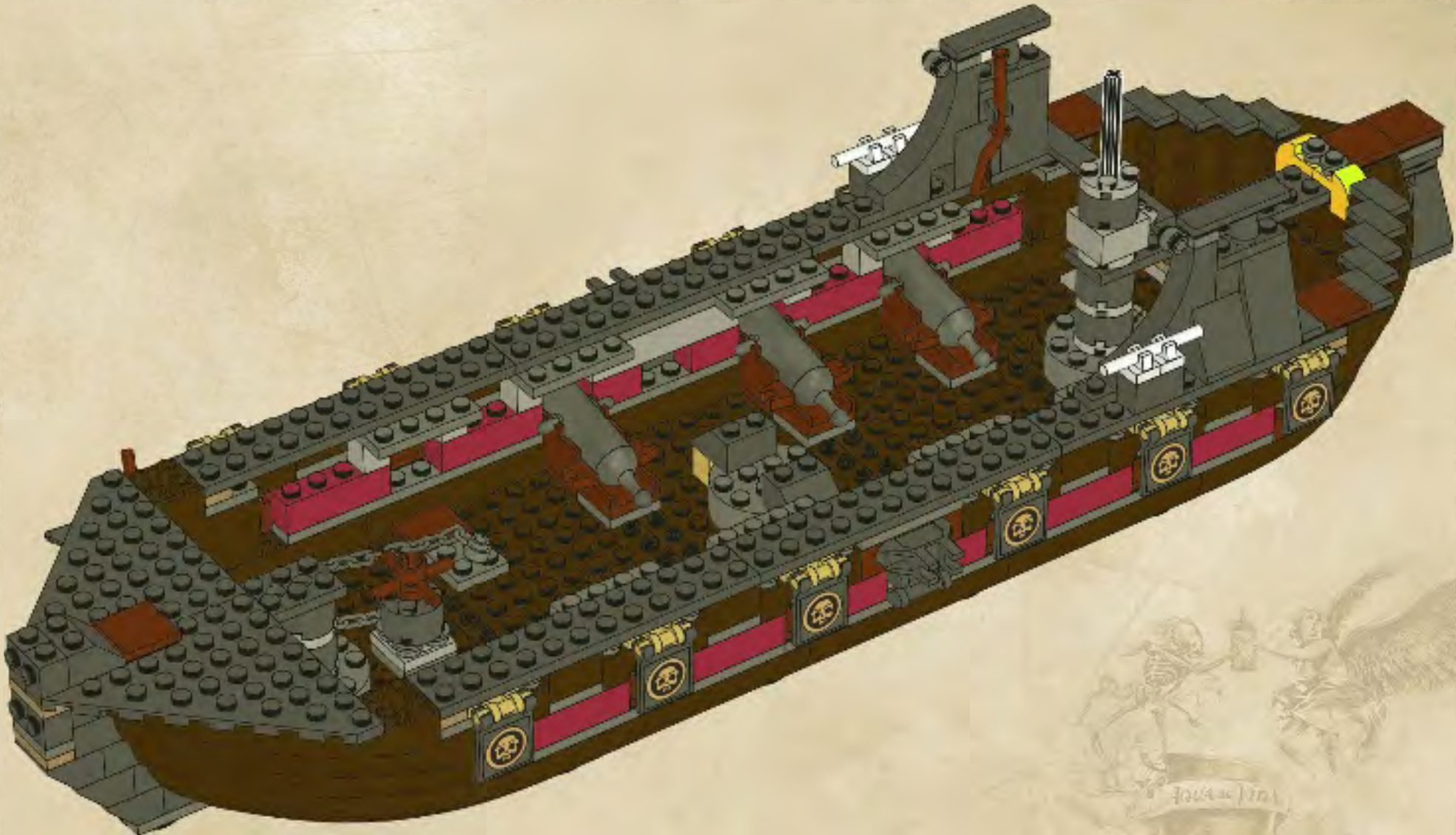



49

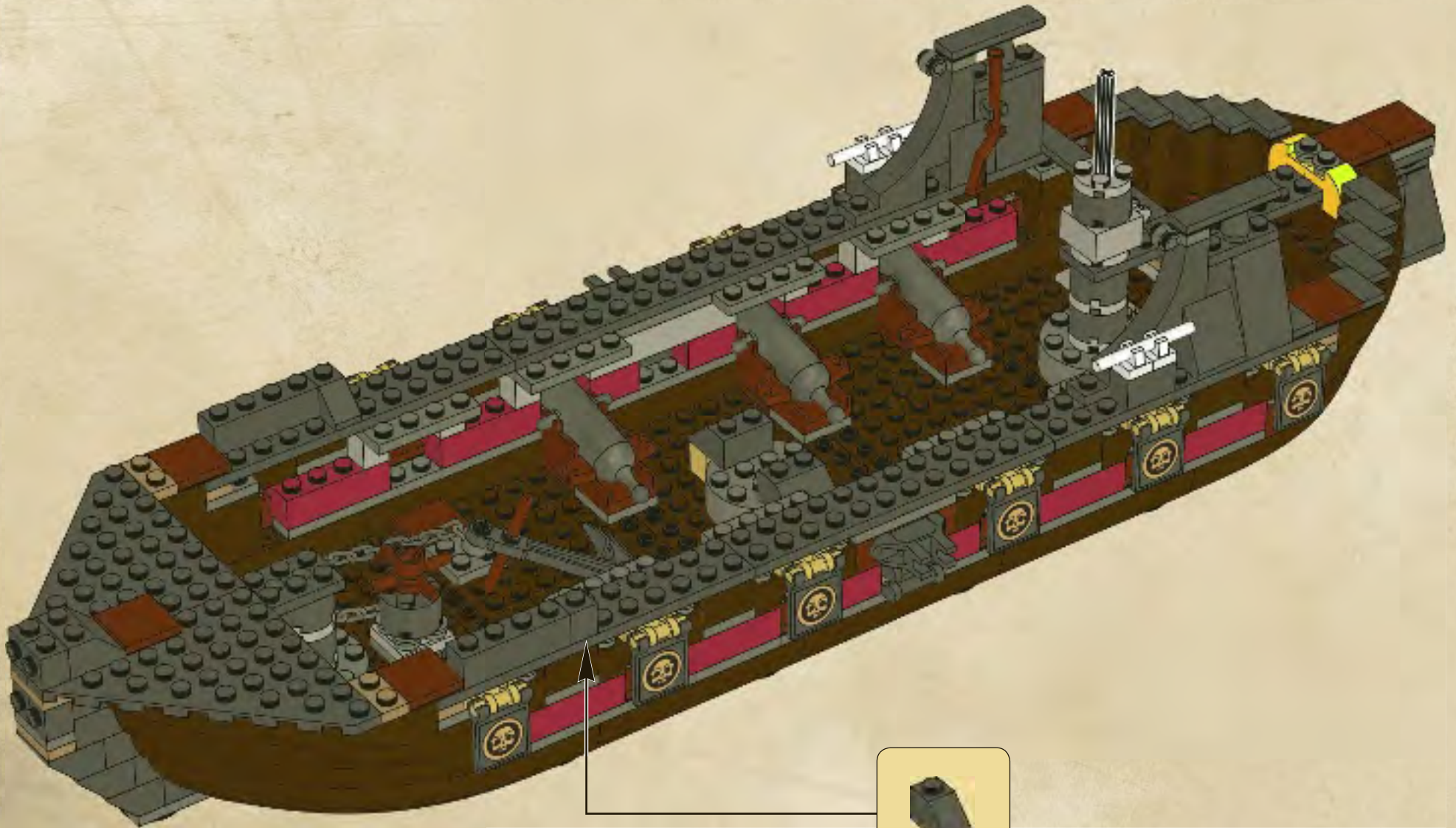



50

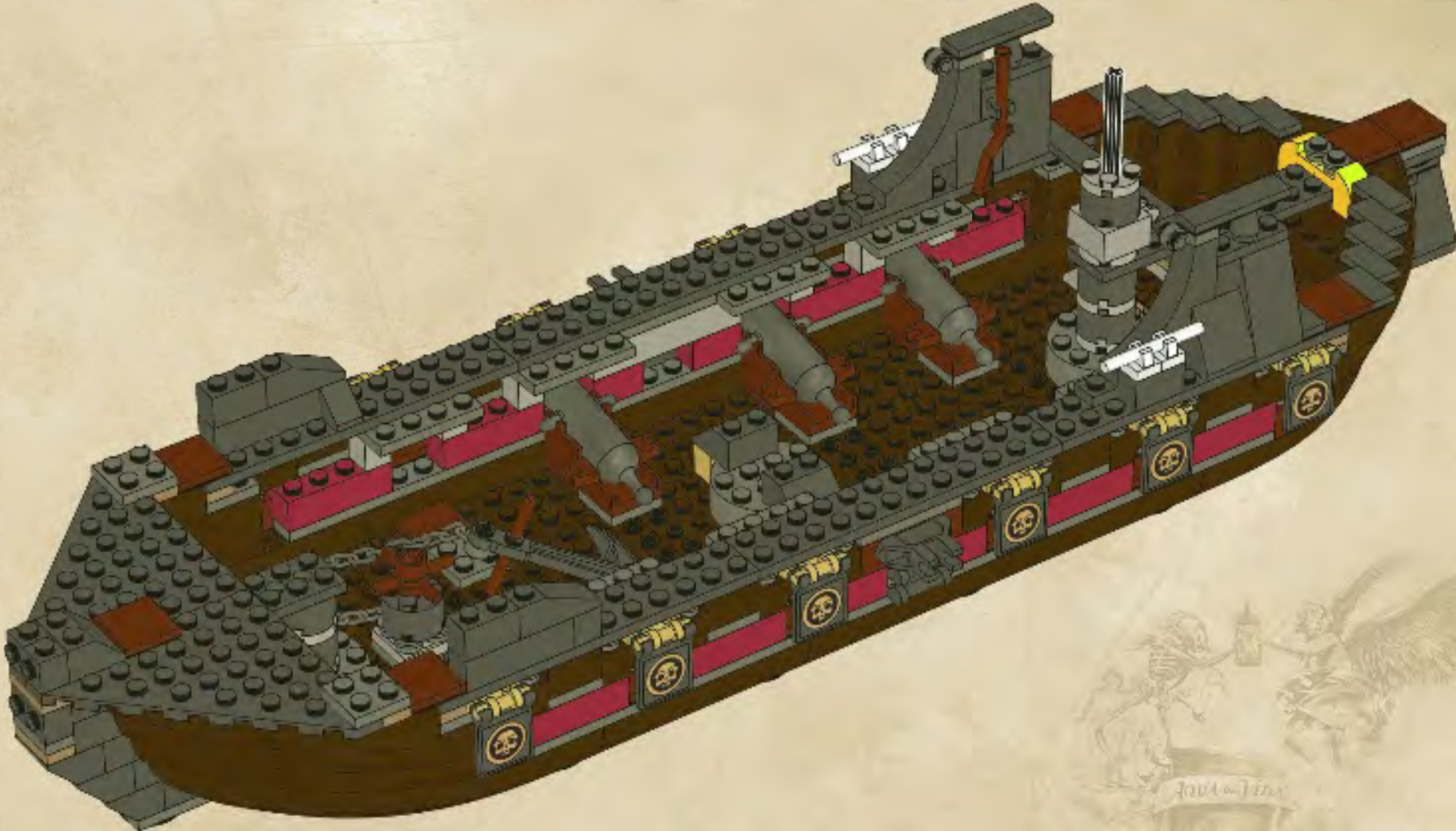

2x 2x

51

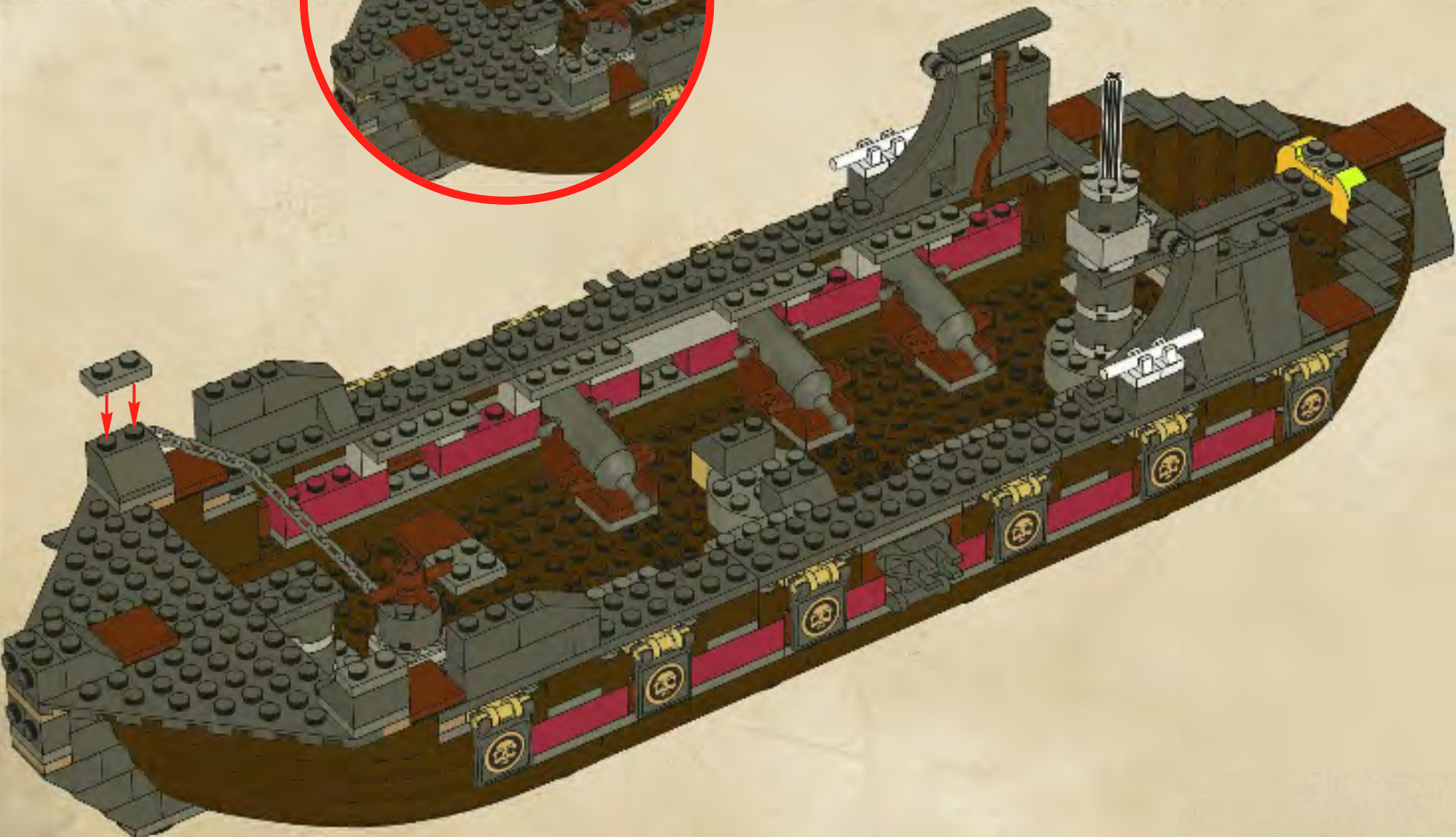

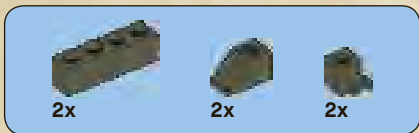

52

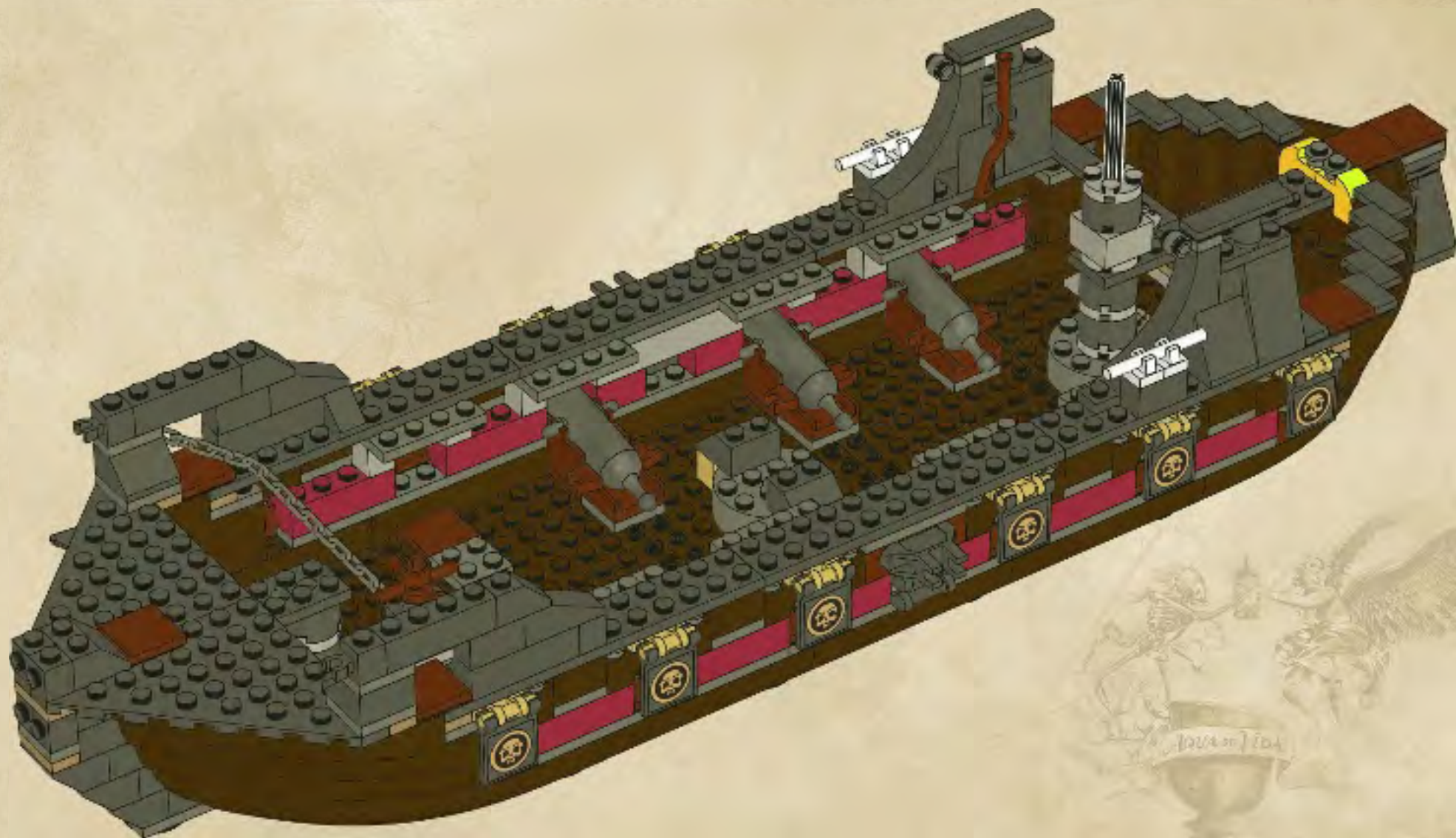





4x

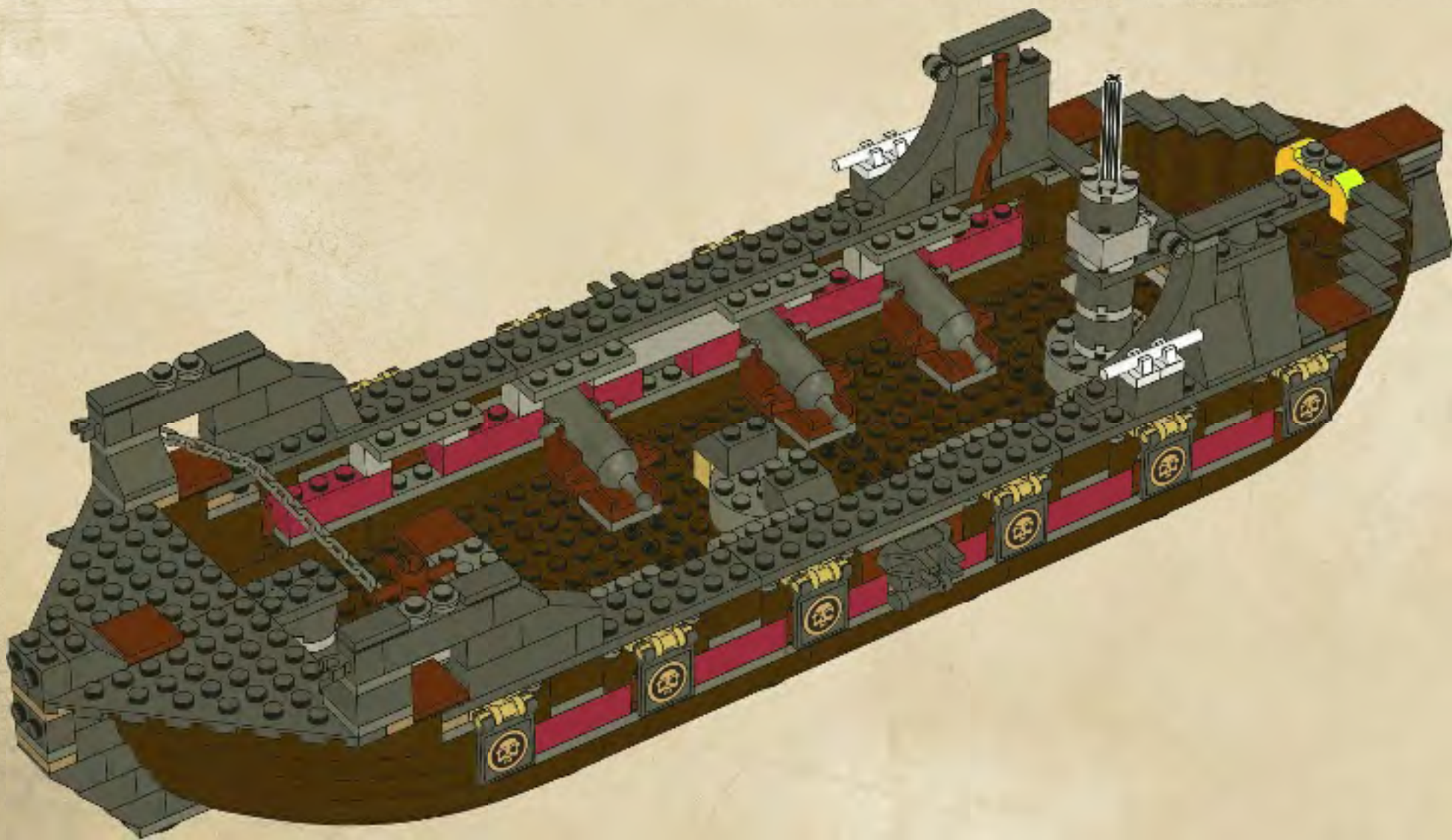

4x

53



4x  2x 

54

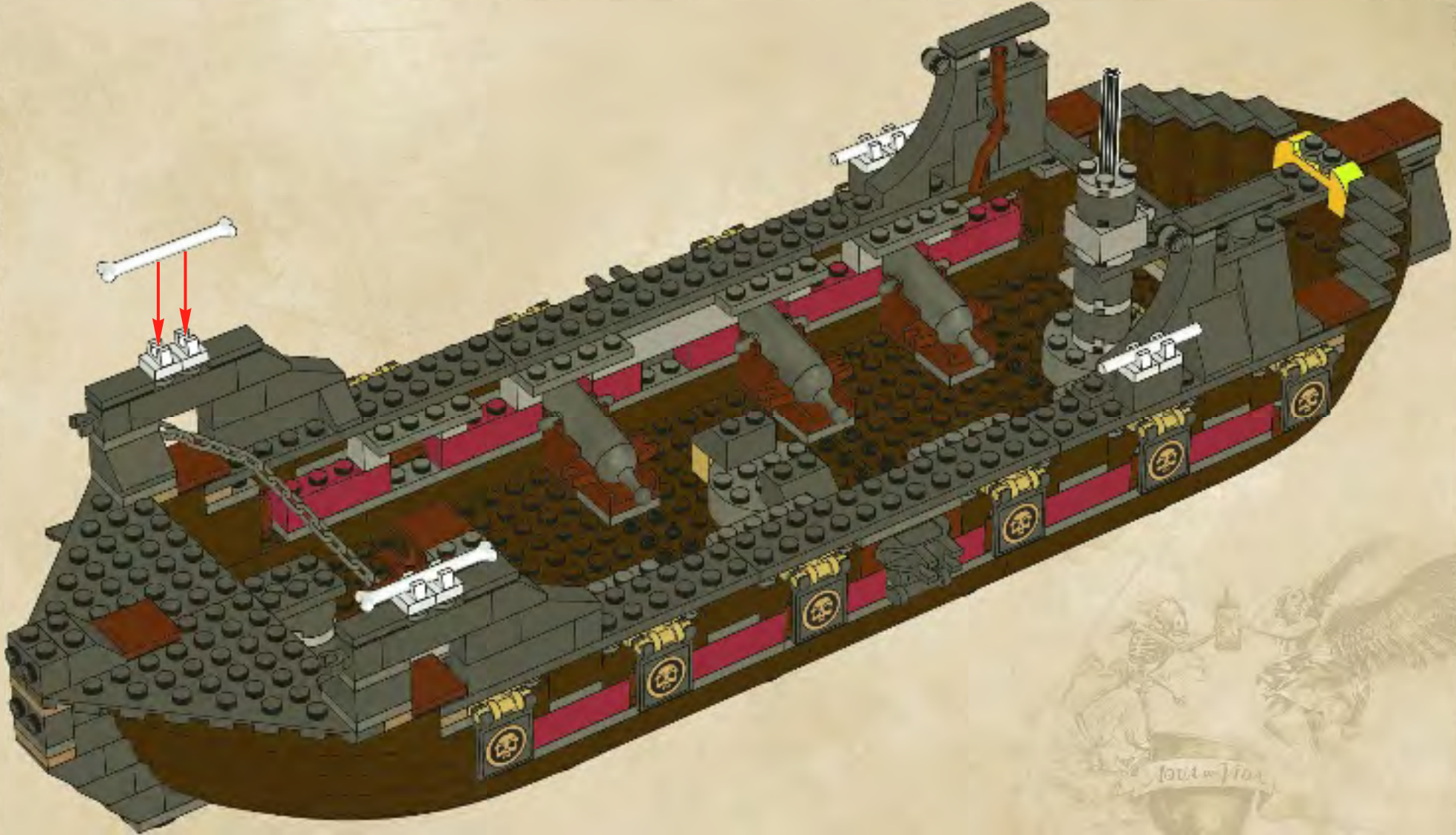

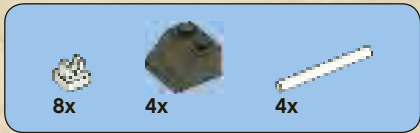

55

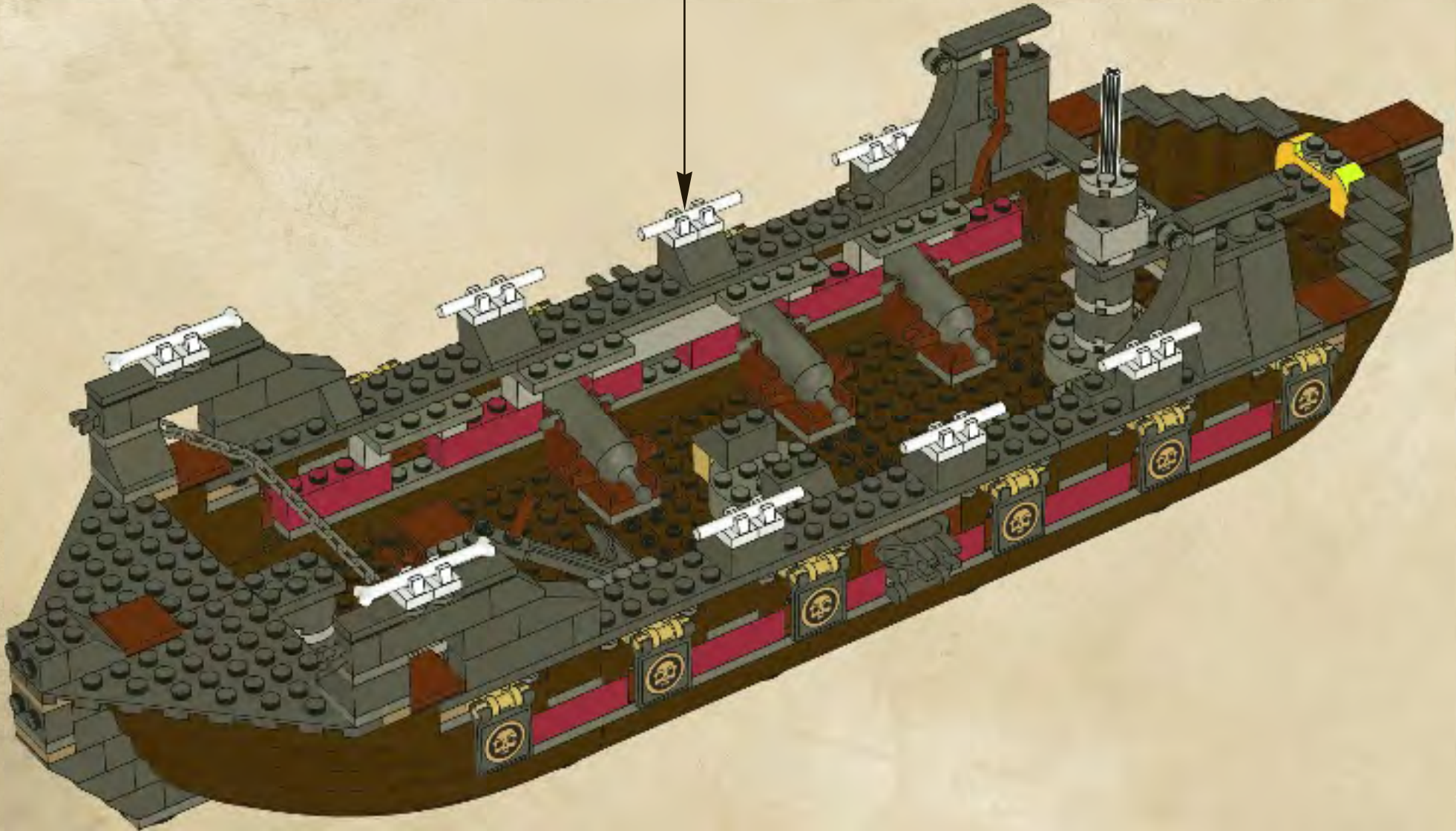
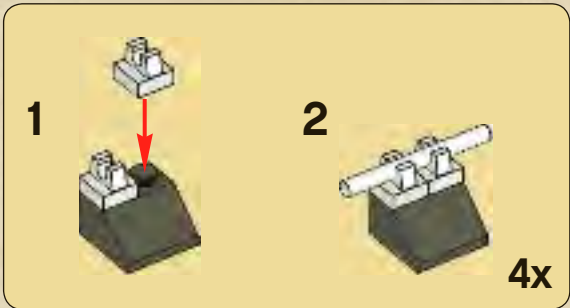

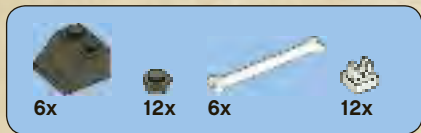

56

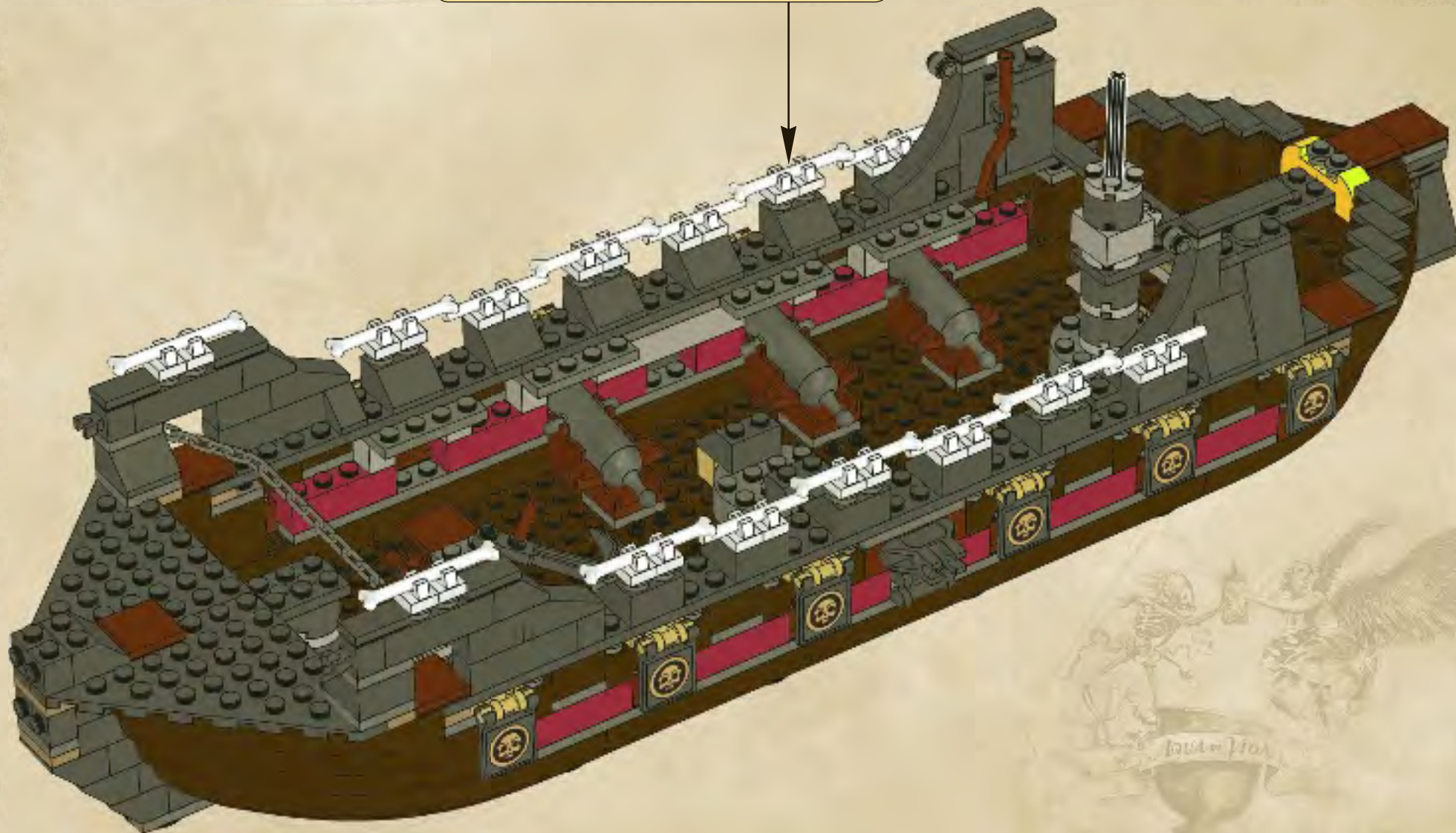
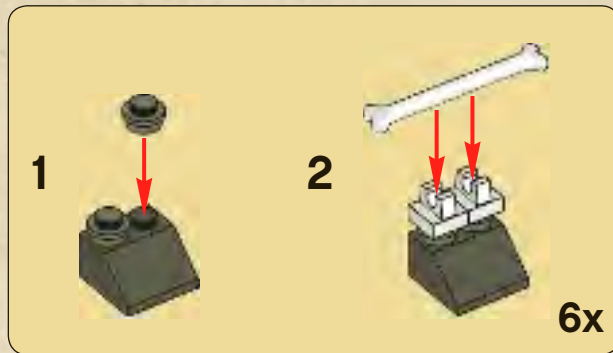



57

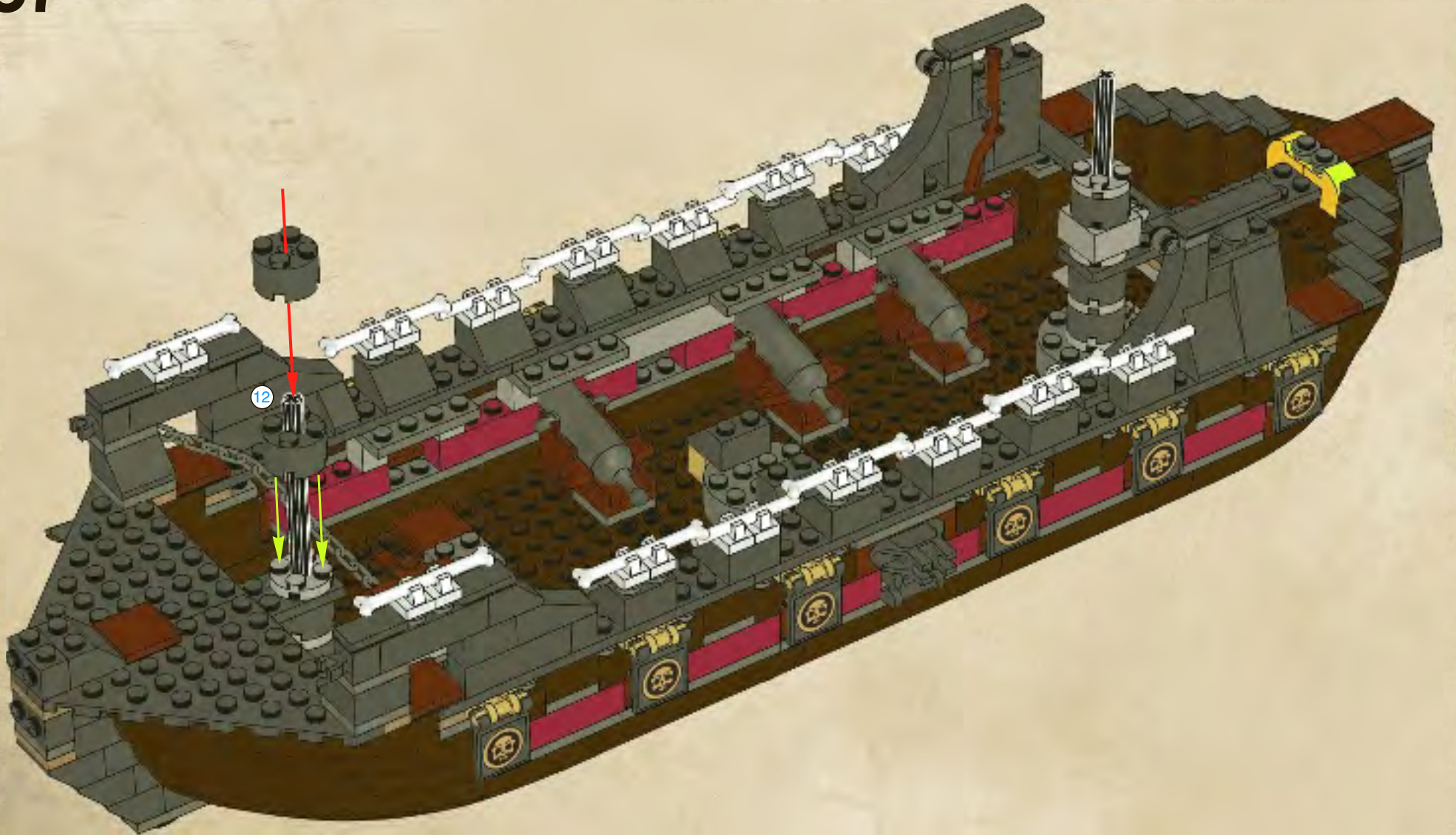

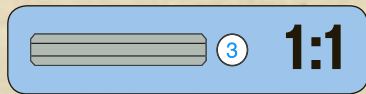

58

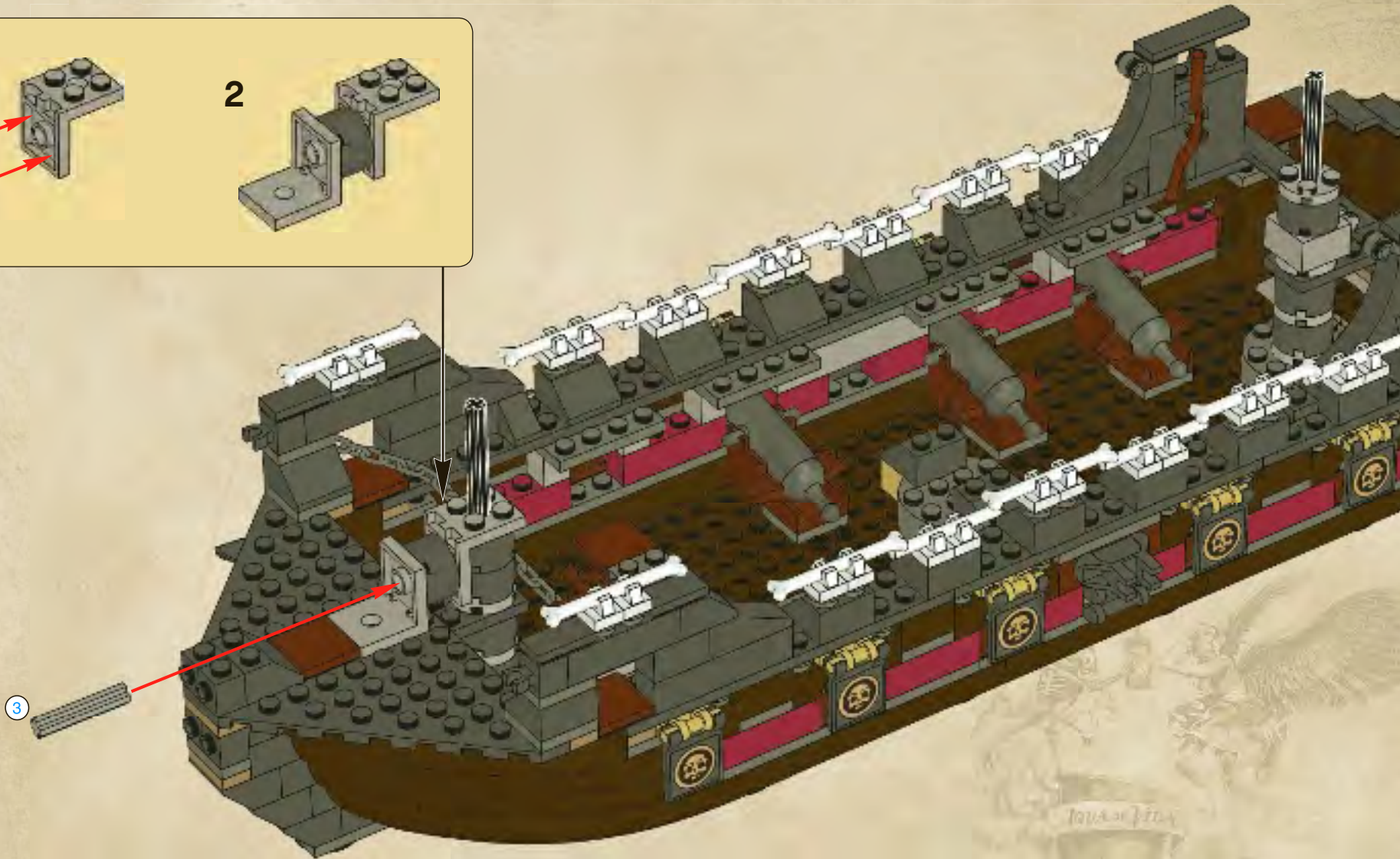
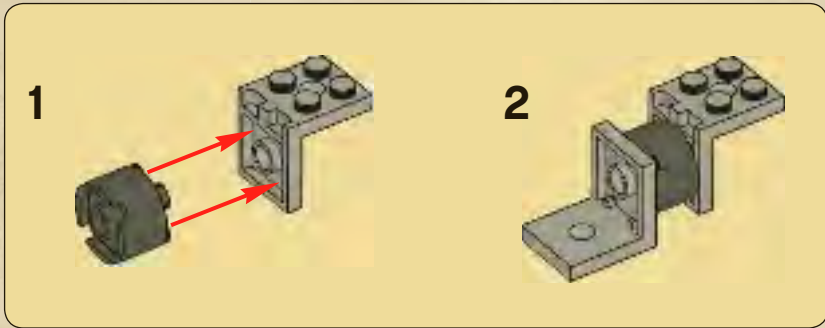



4x

59

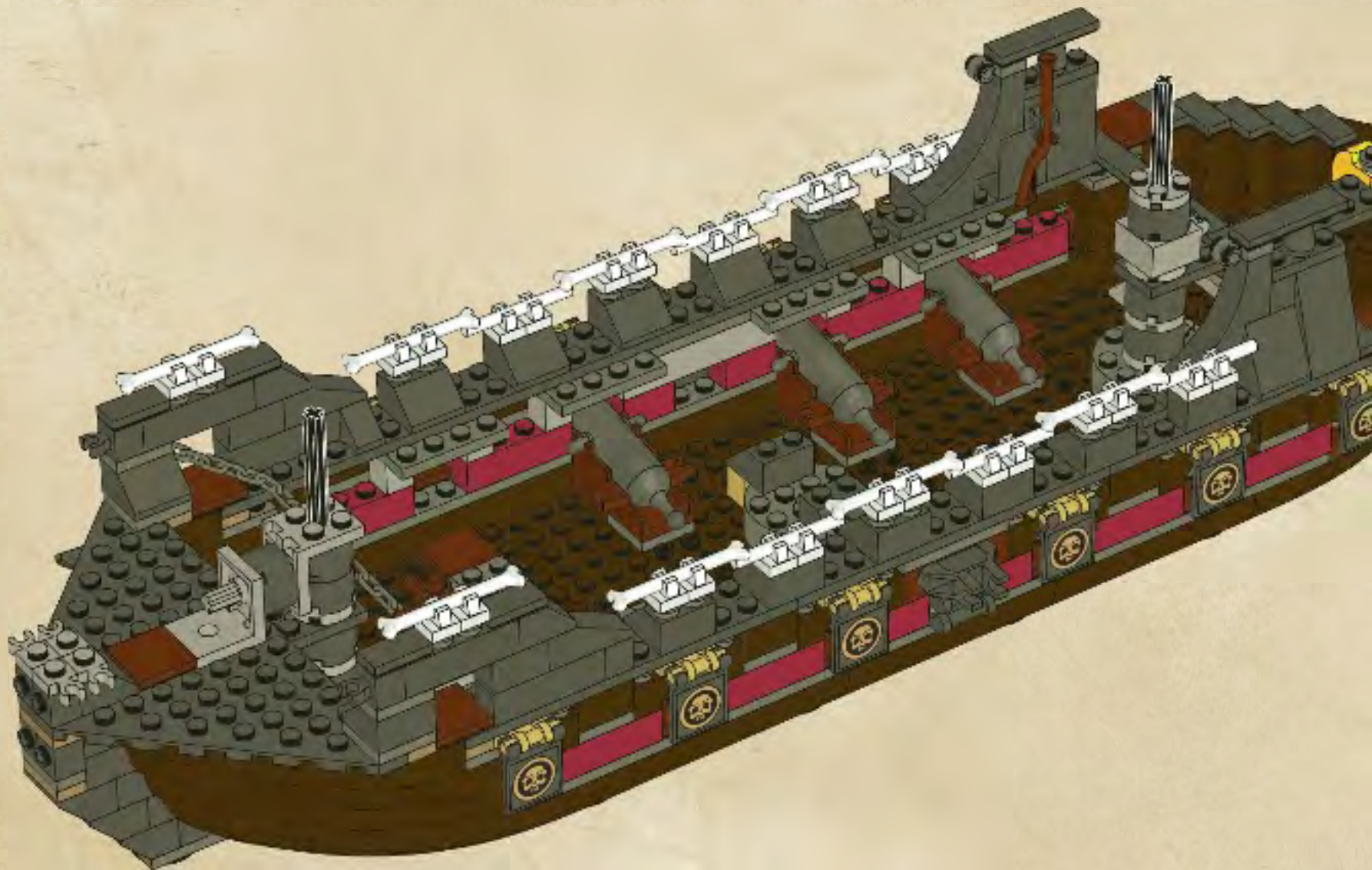



1x



2x

60

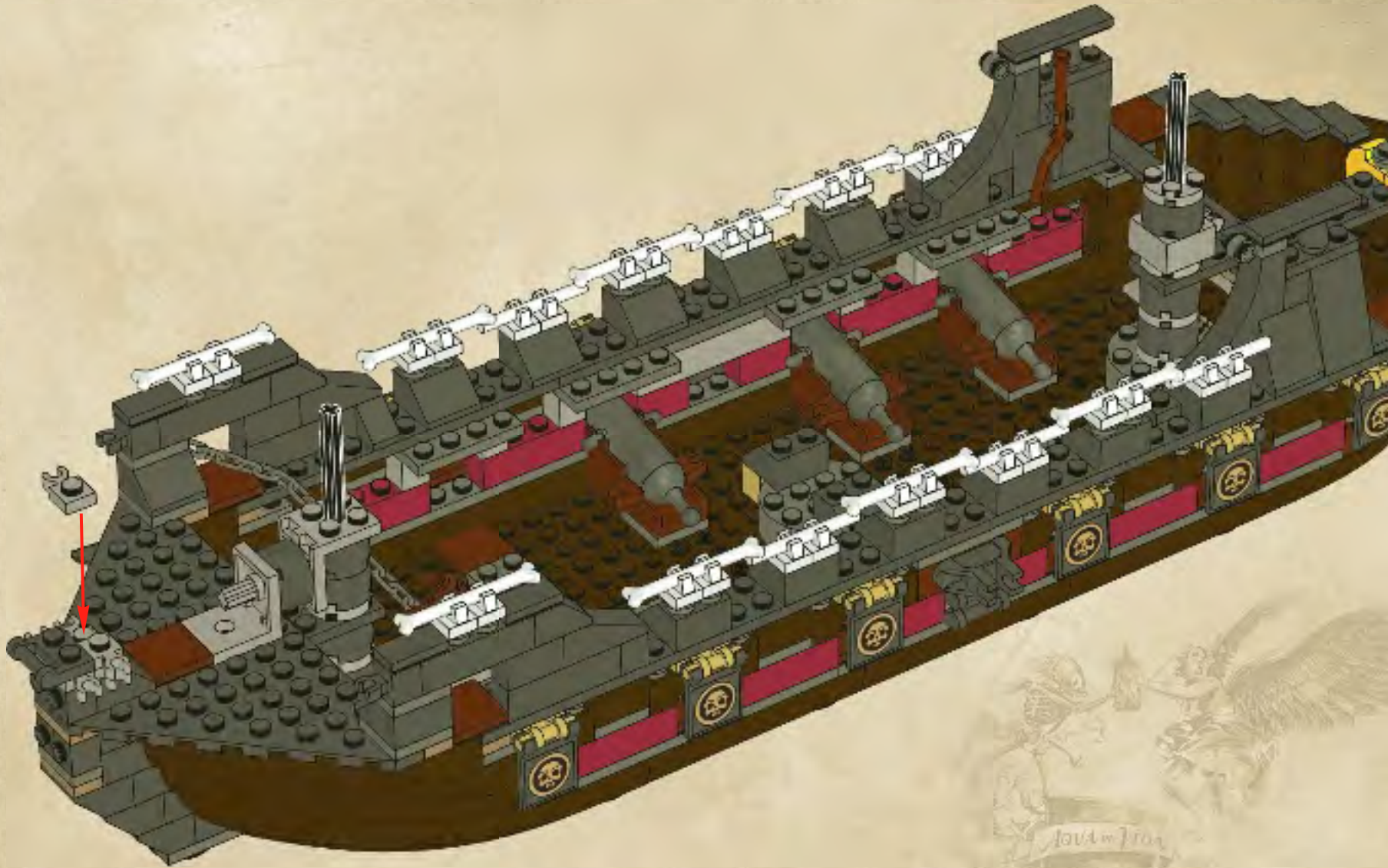

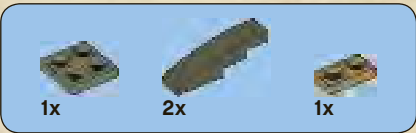

61

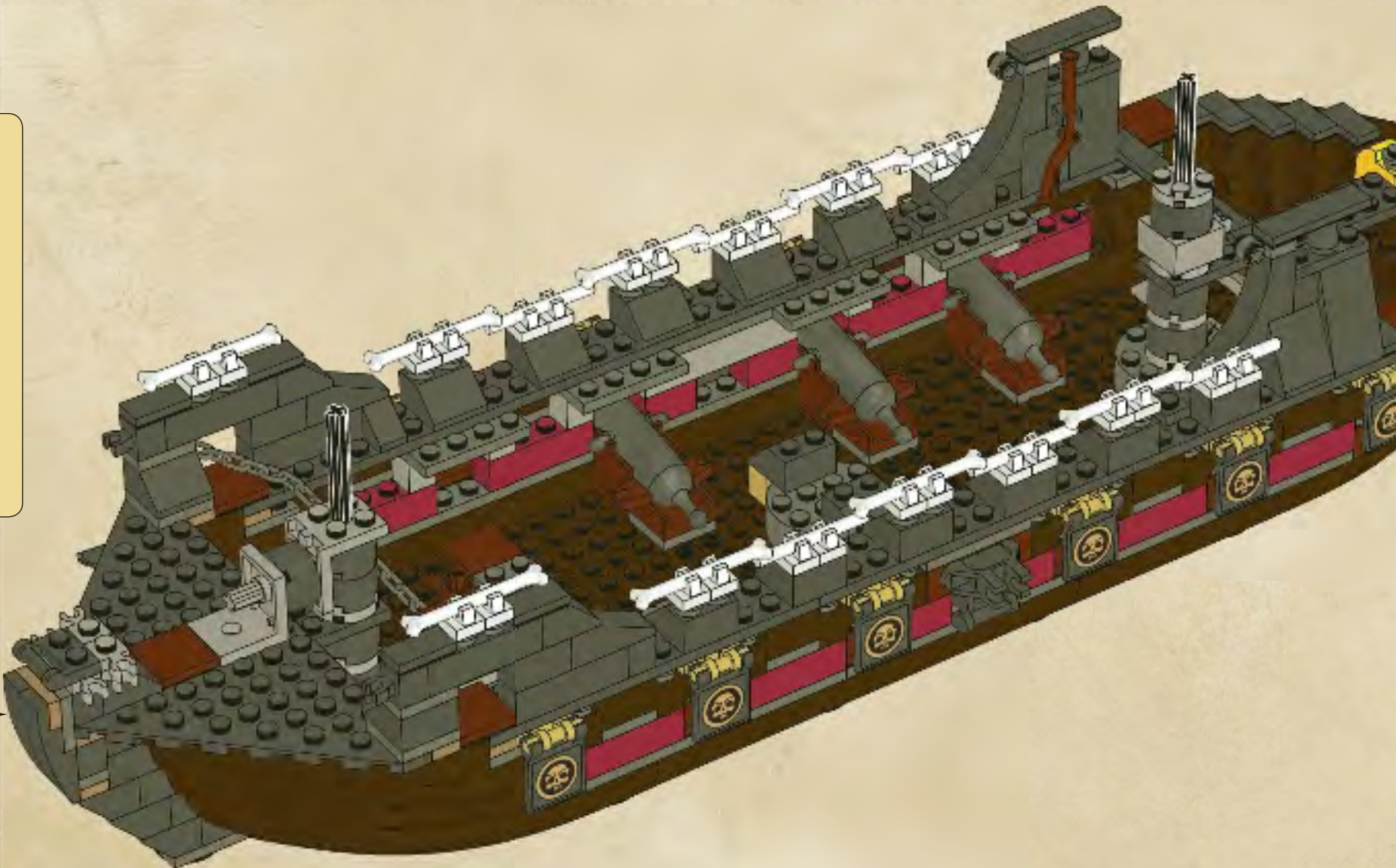
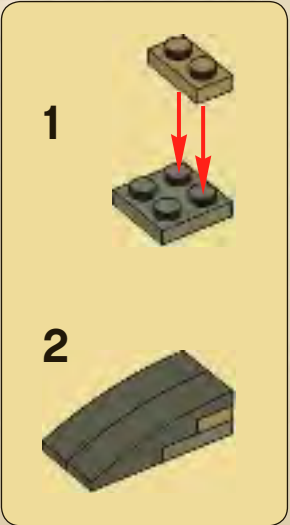



62

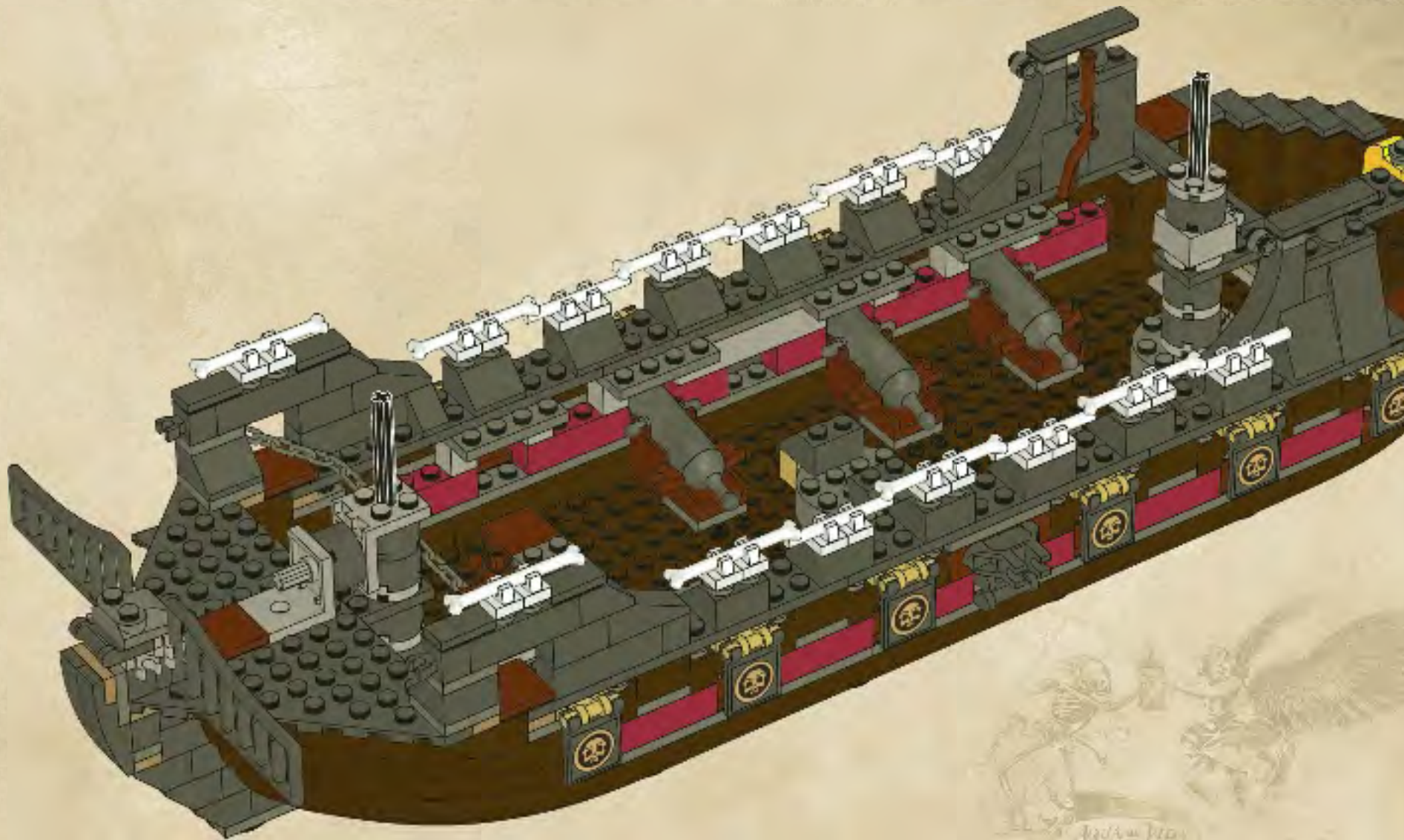

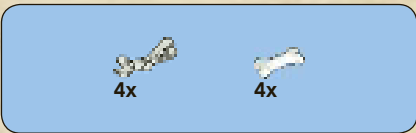

63

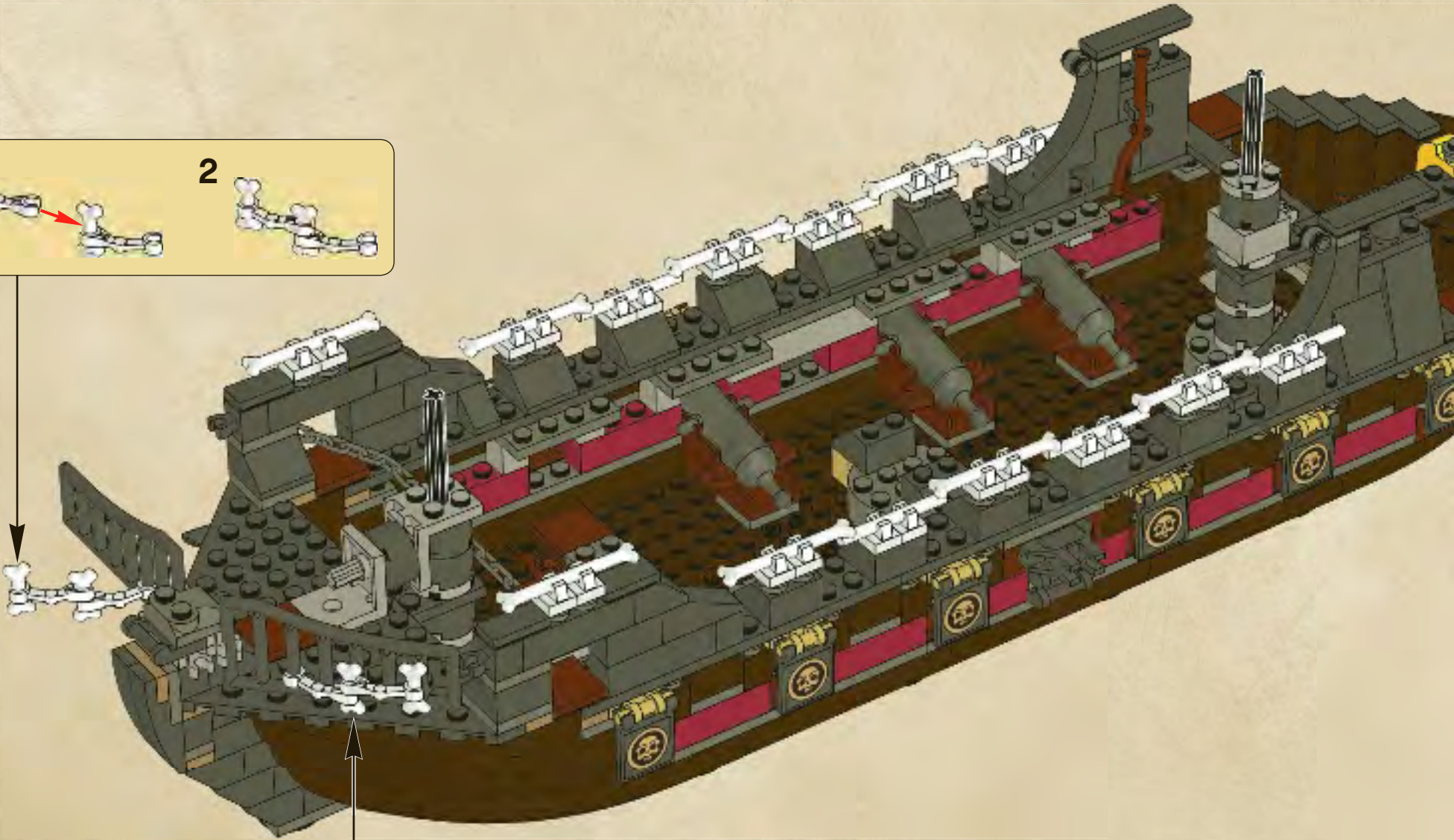
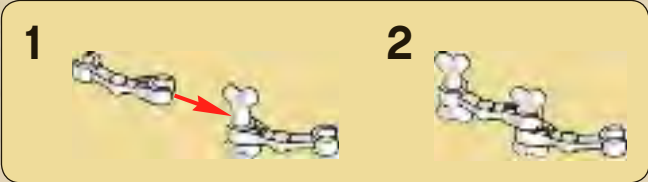

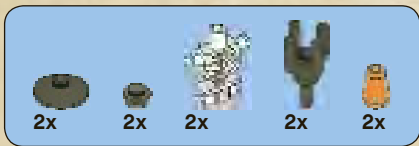

64

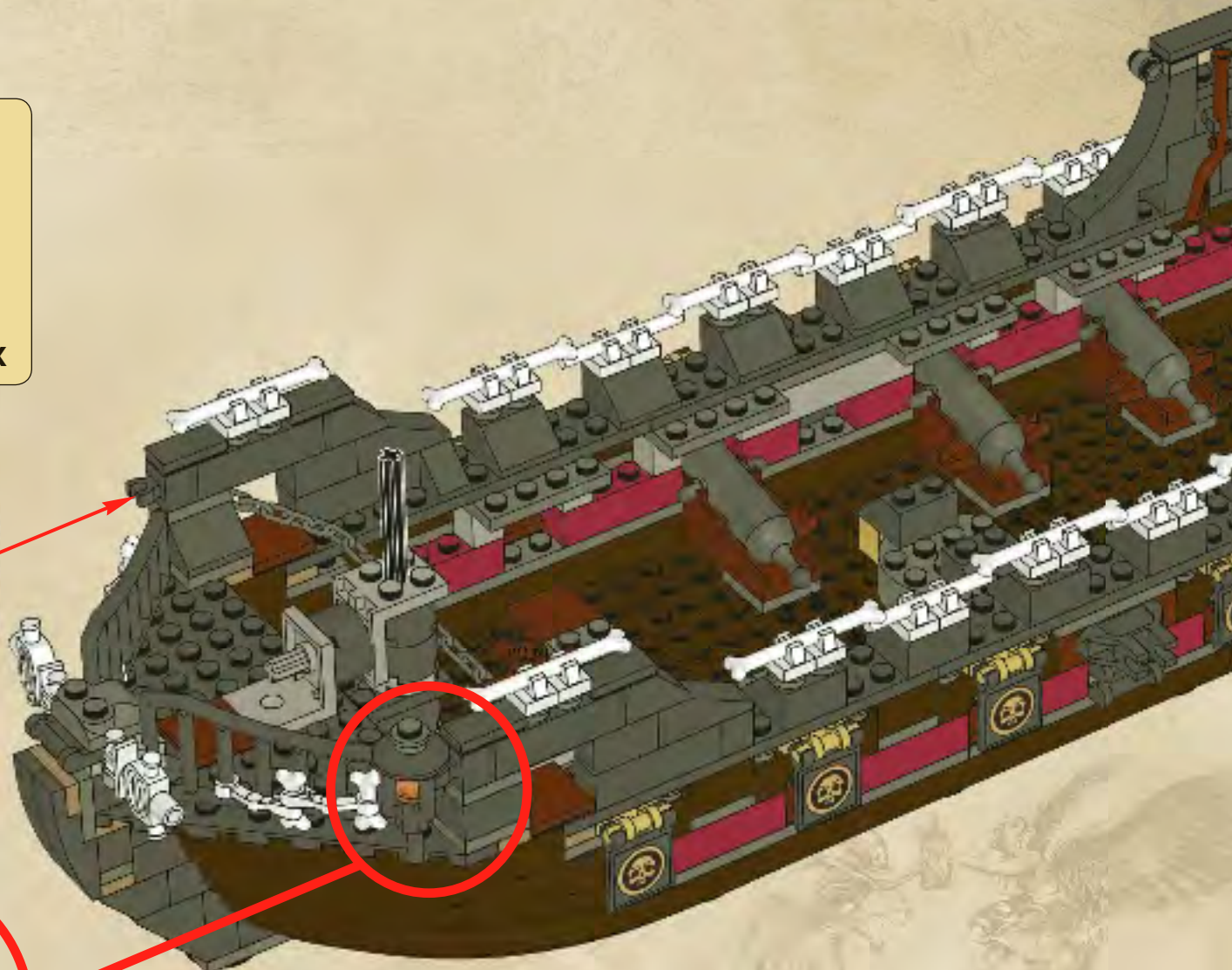



65

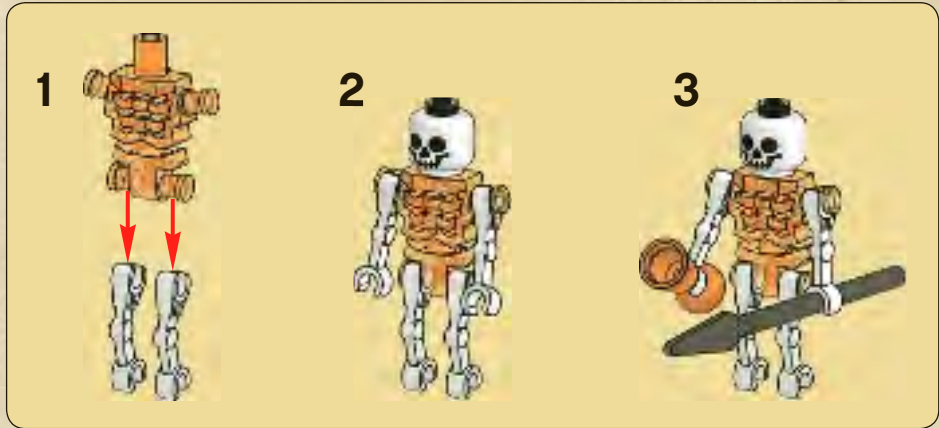

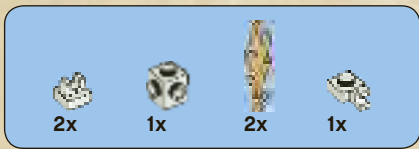

66

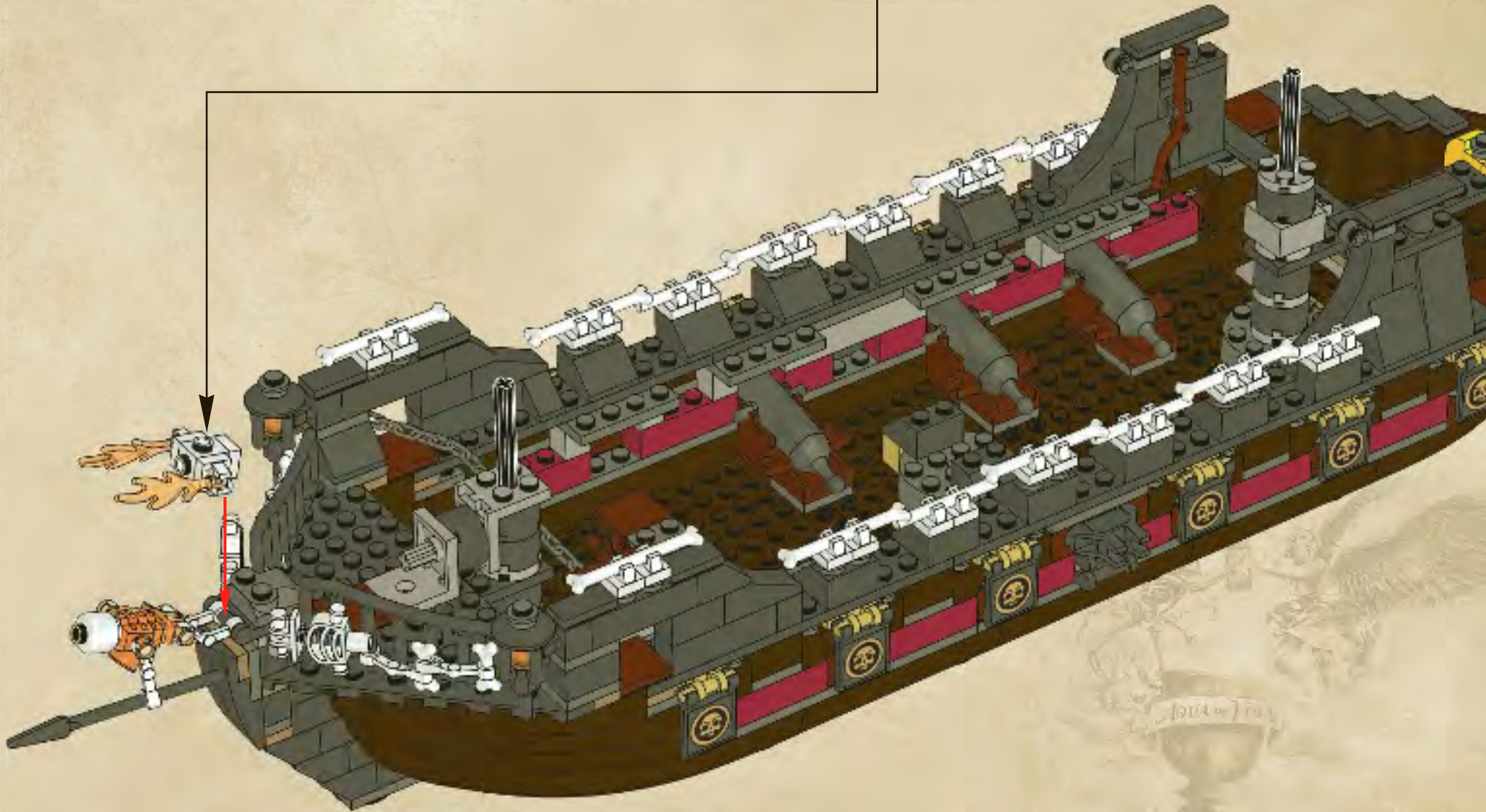
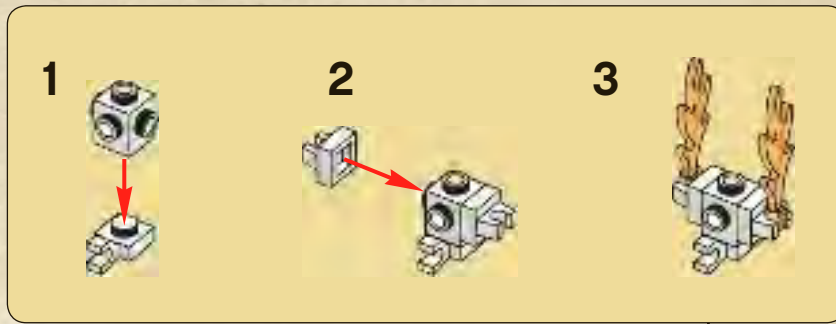

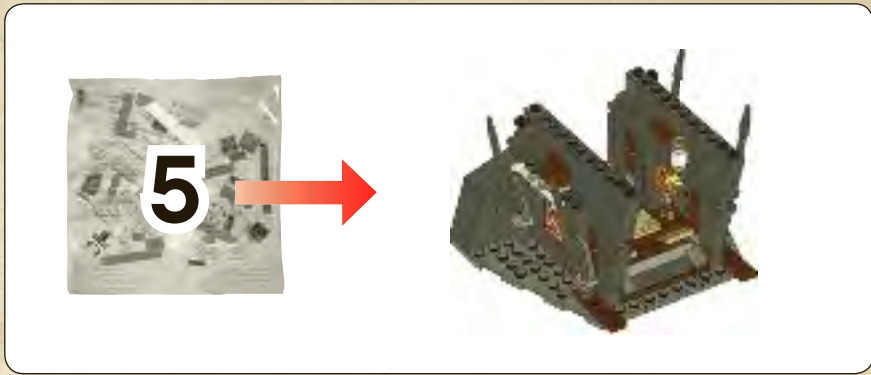

1

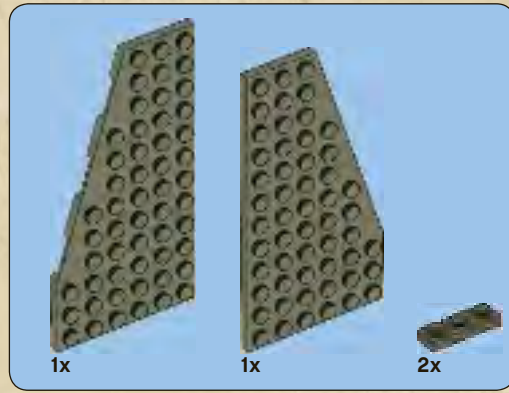

2





3

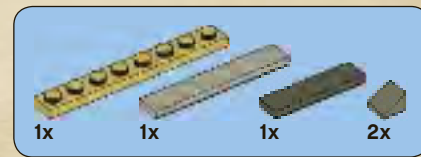
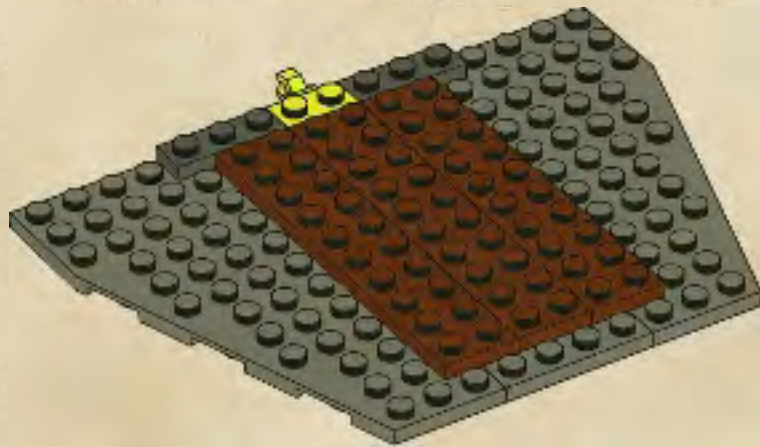

4

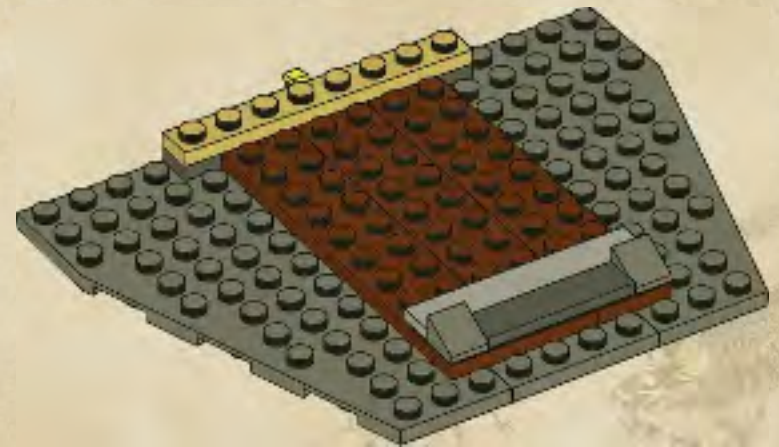



5

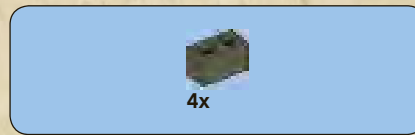
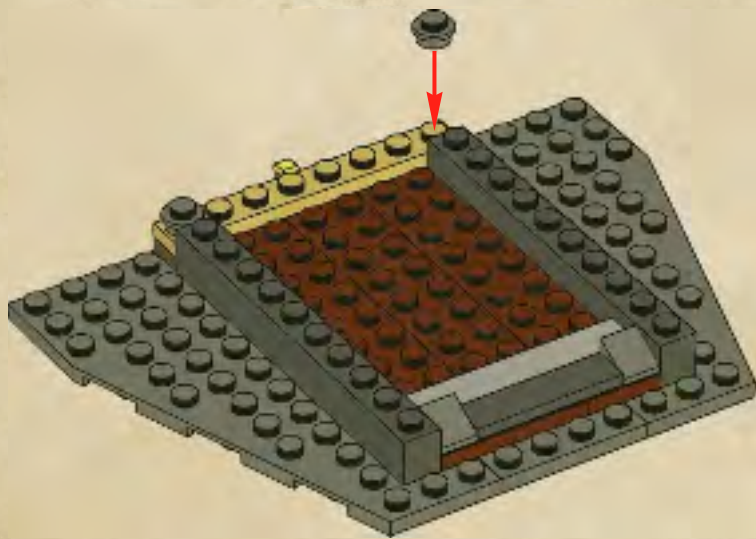

6

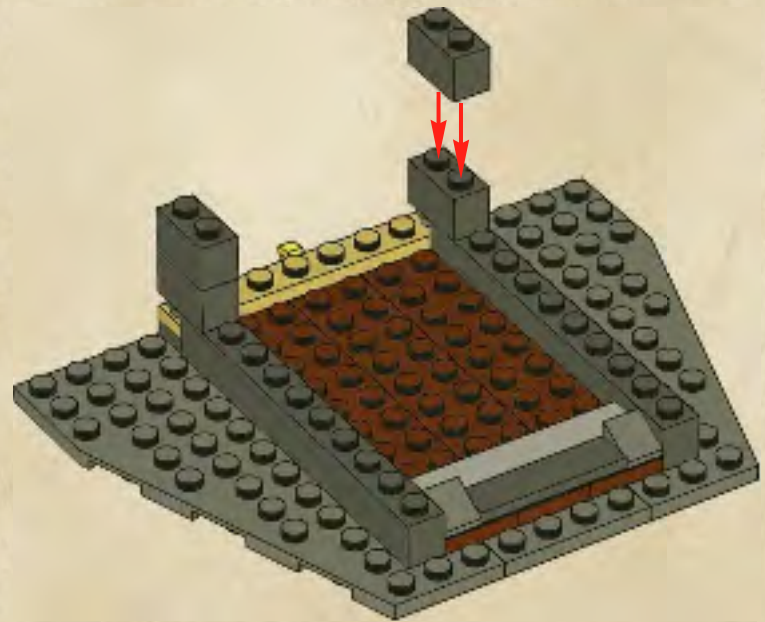



7

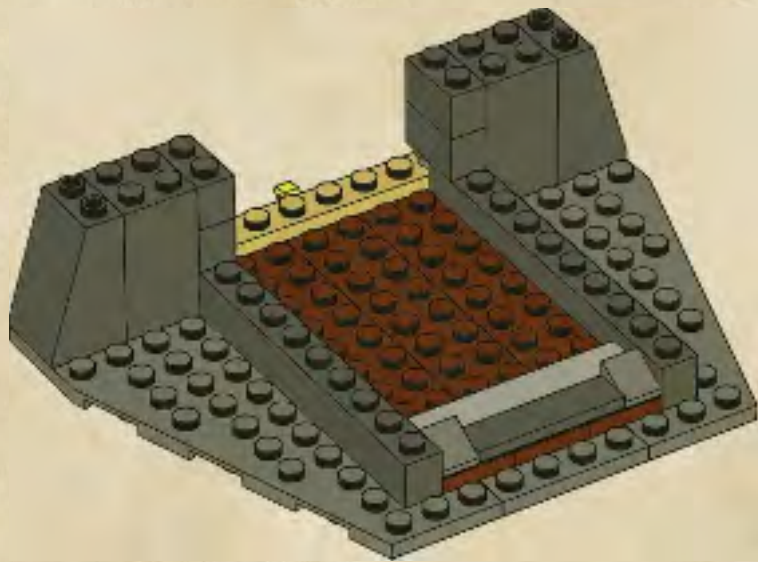

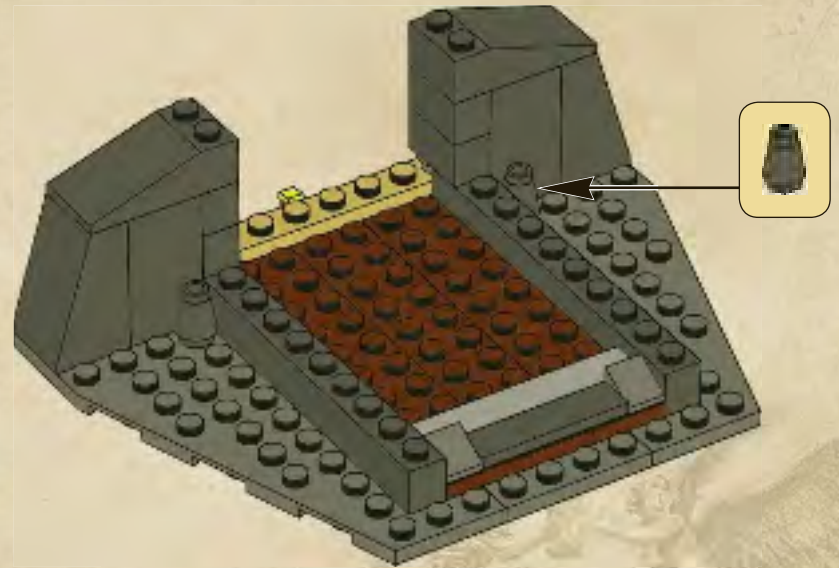

8

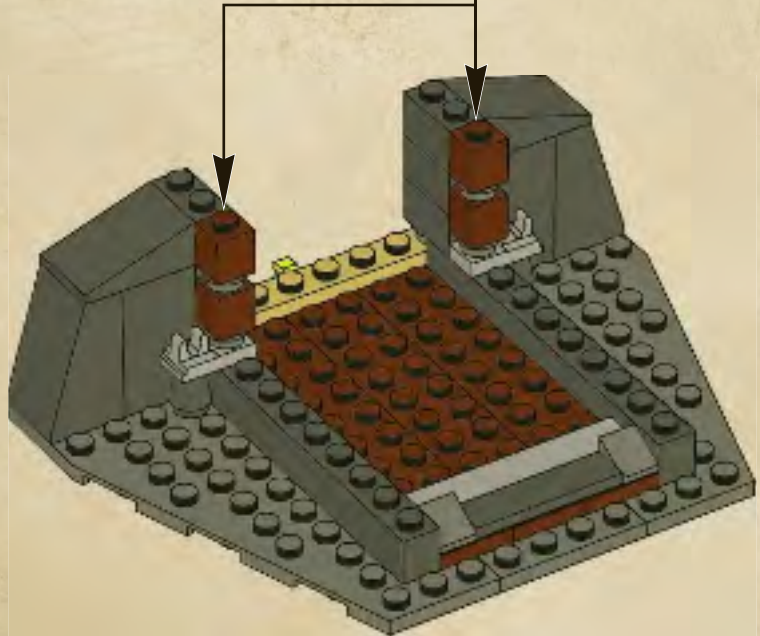
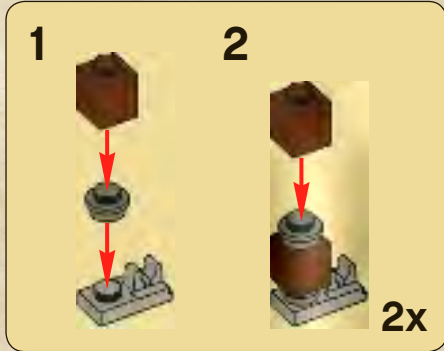

- 4x 
- 4x 
- 2x 

9



- 2x 

10





11

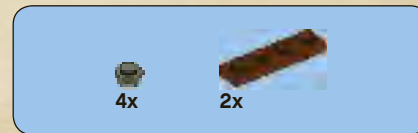
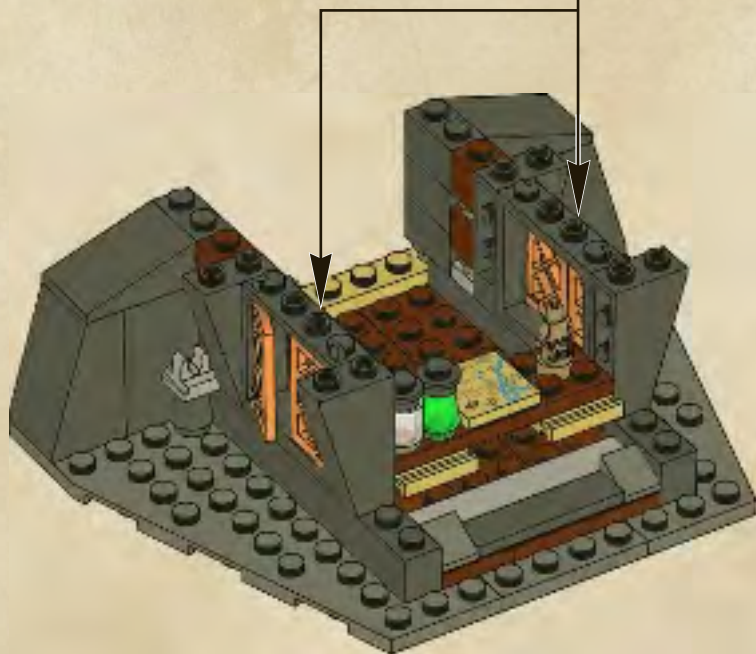
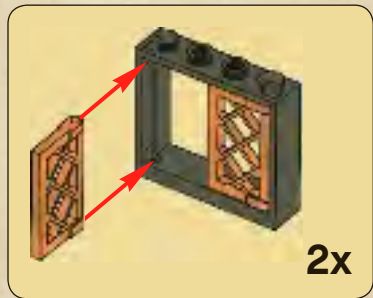

12

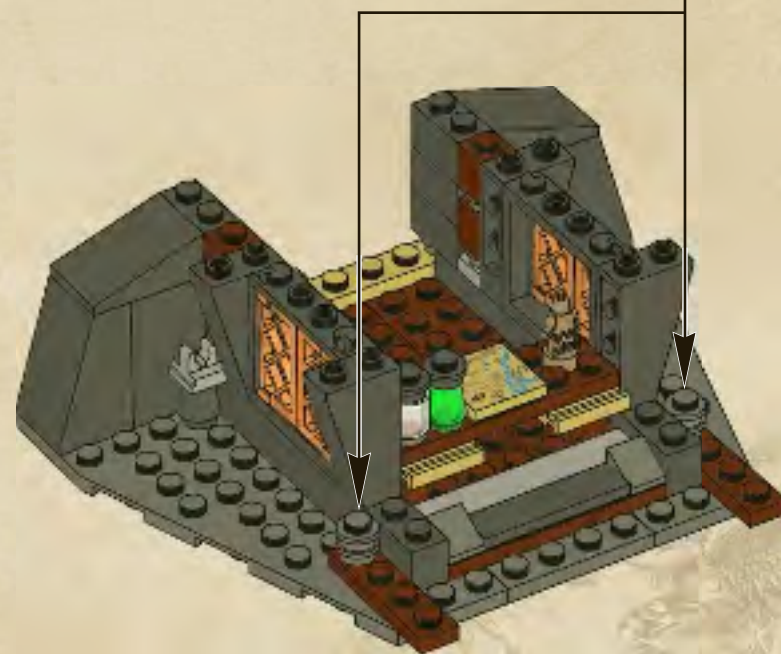

-  4x
-  4x
-  2x

13

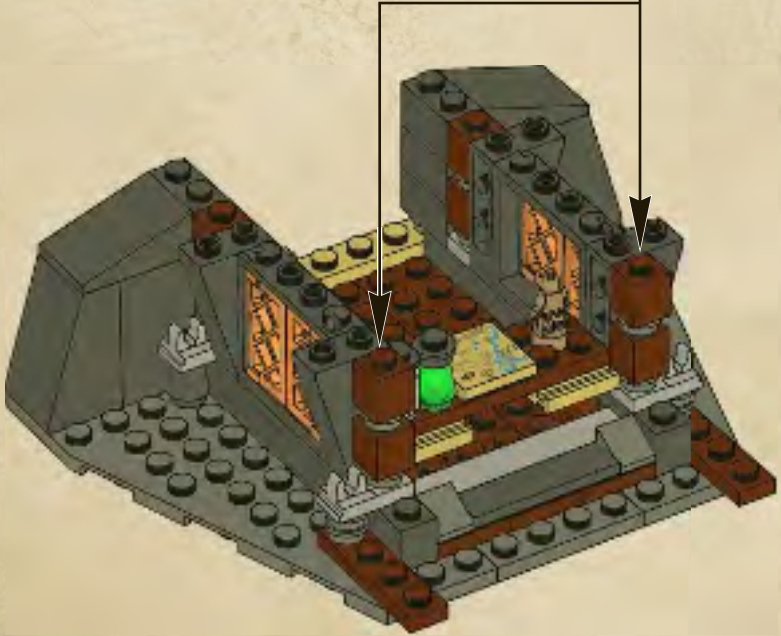
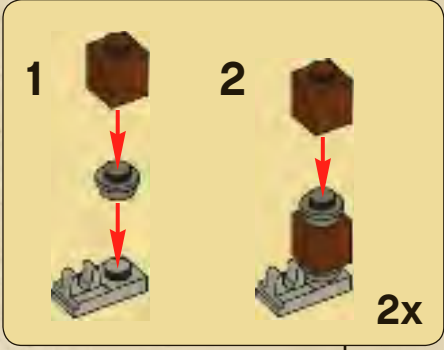

-  2x

14

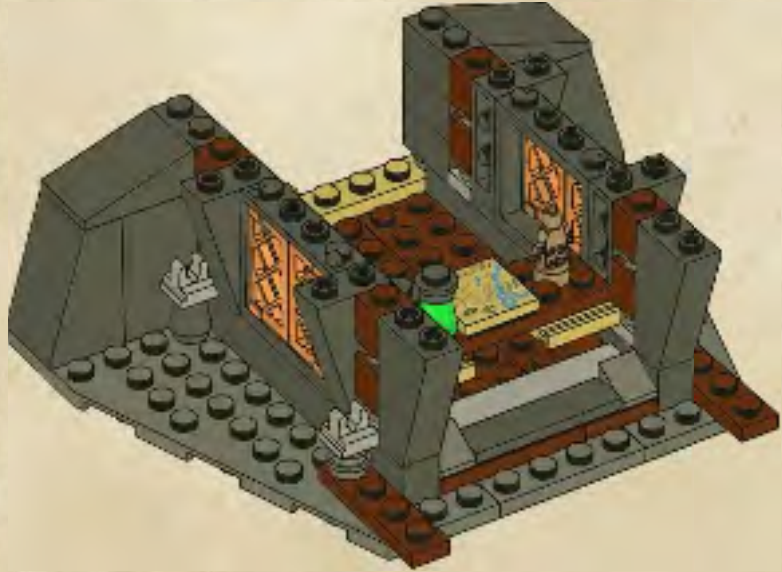



15

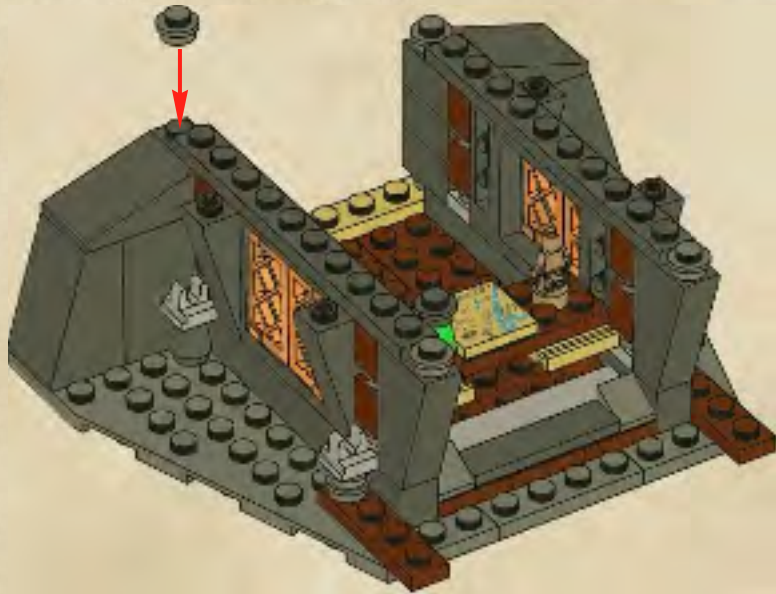

16



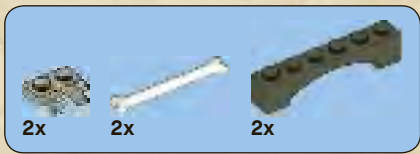

17

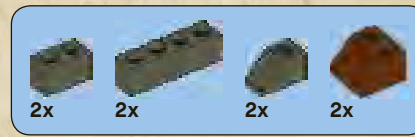
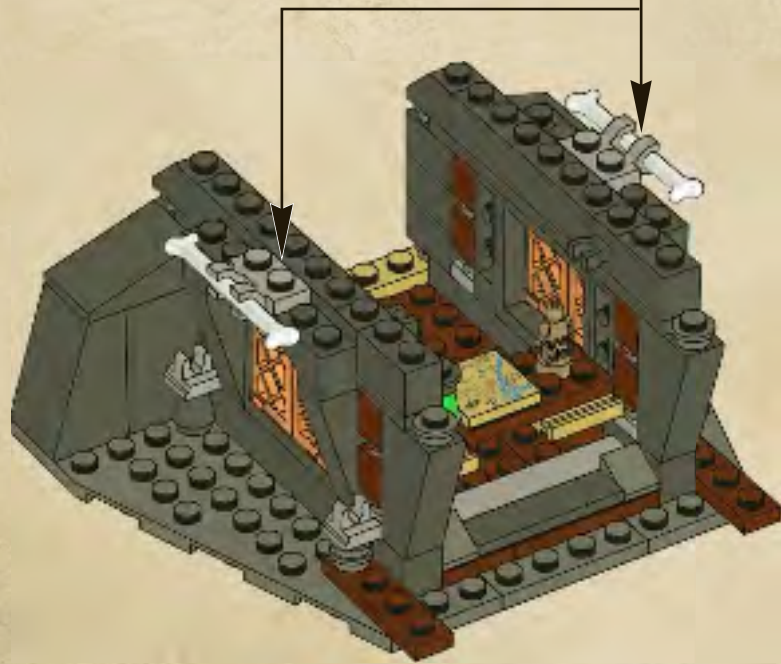
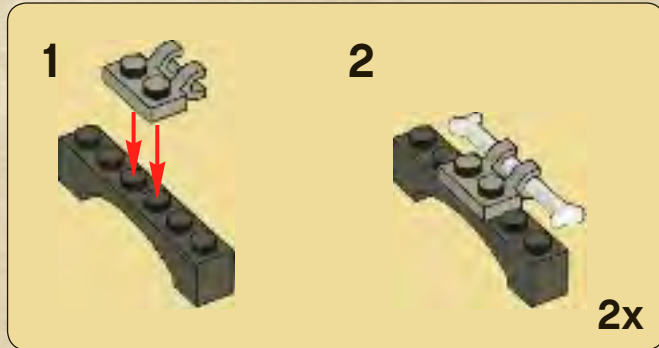

18

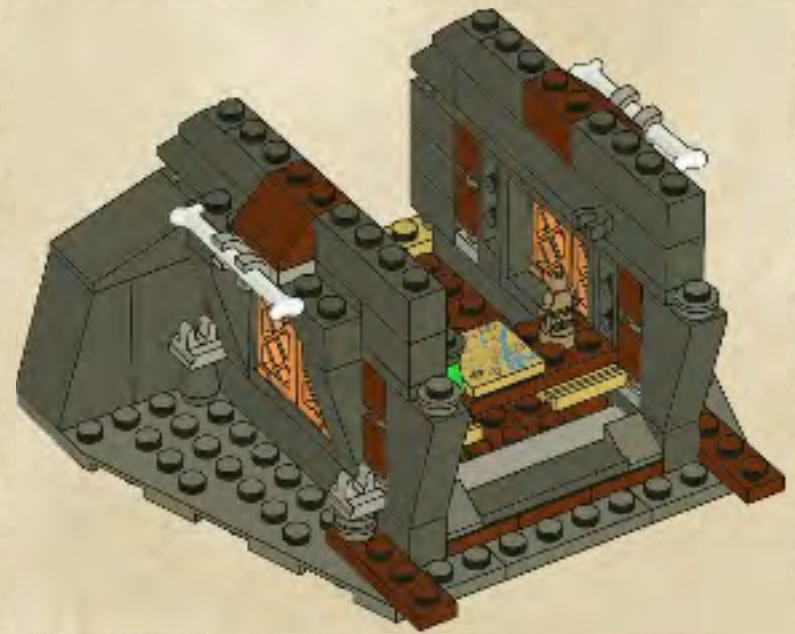

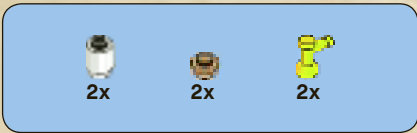

19

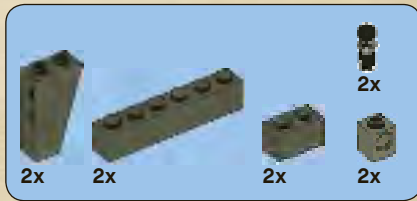
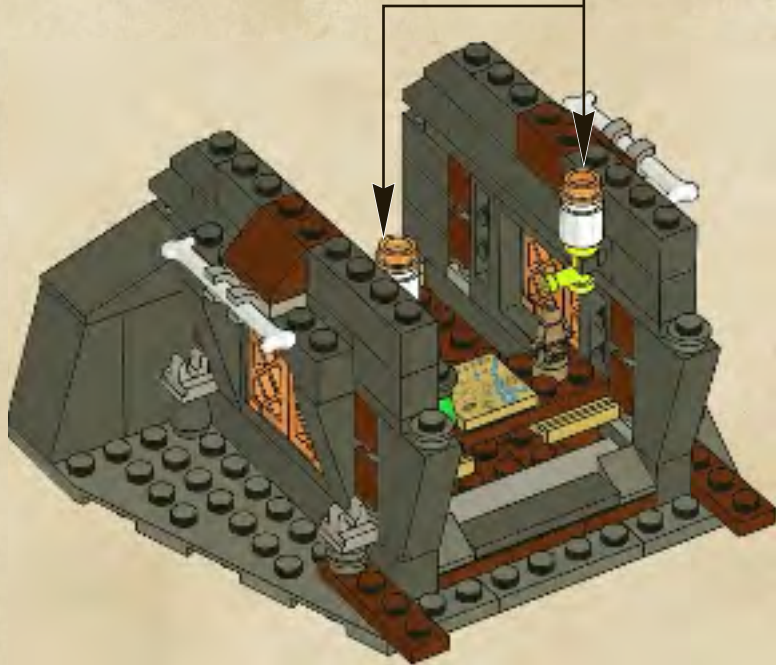

20

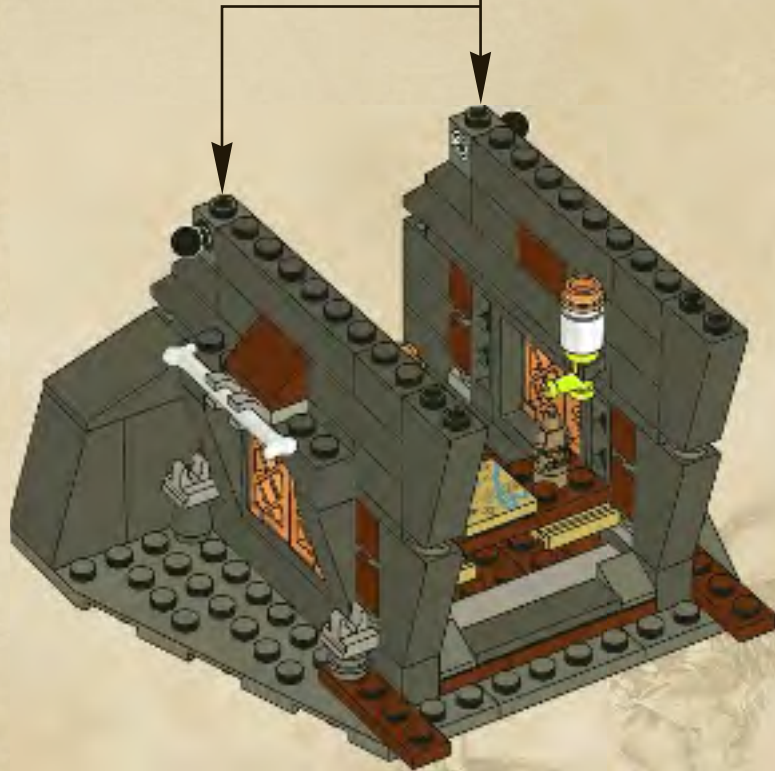
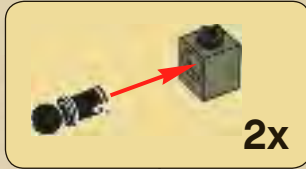

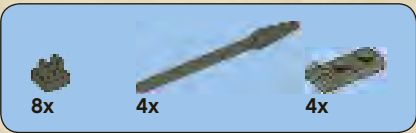

21

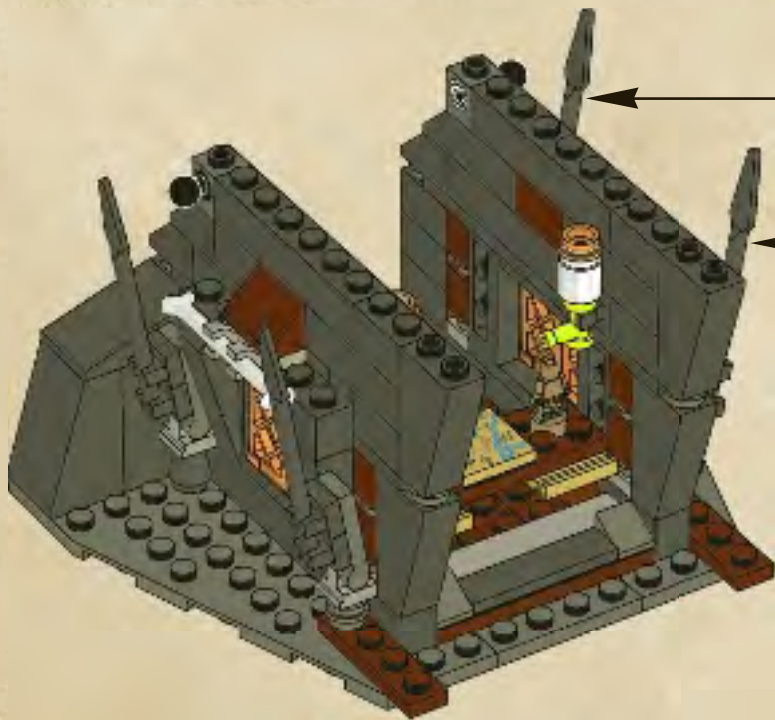

1

2

3

4x

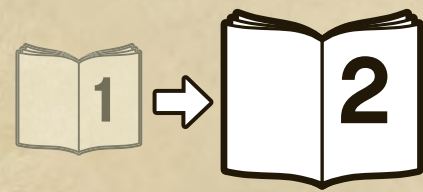



PIRATES of the CARIBBEAN

ON STRANGER TIDES



4195





22



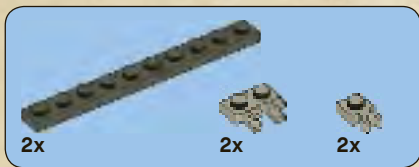

23

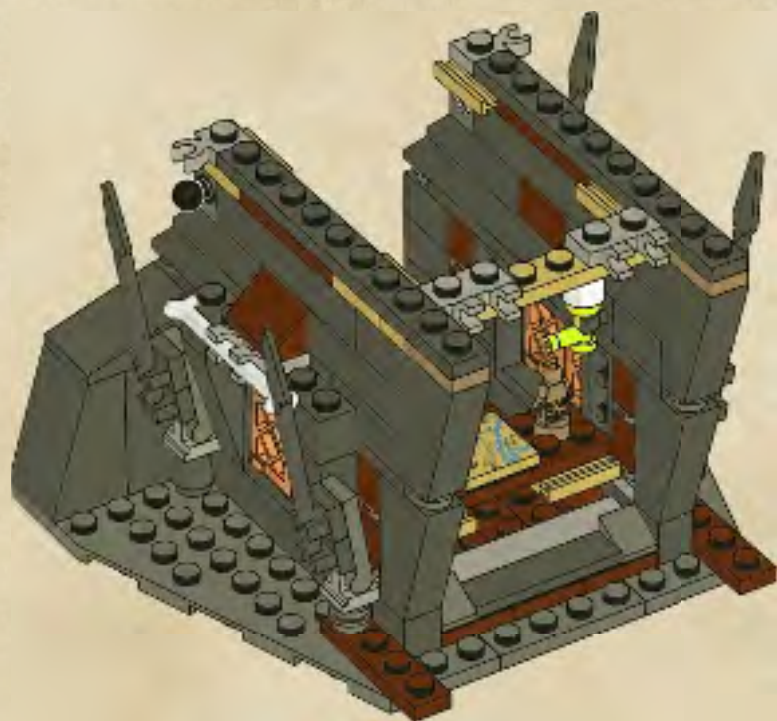

24



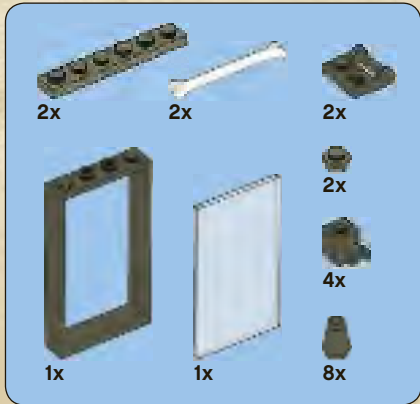

25

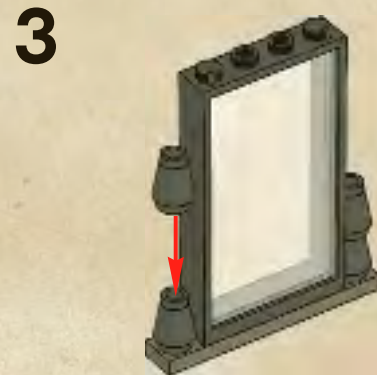
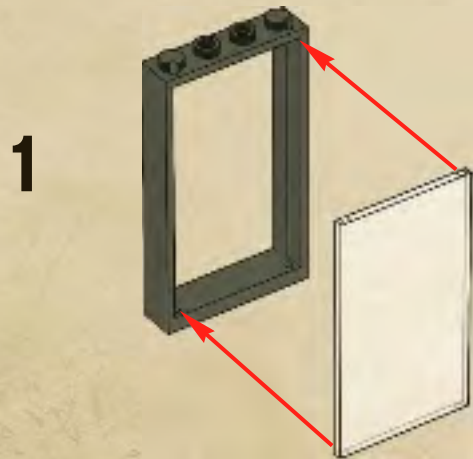

4

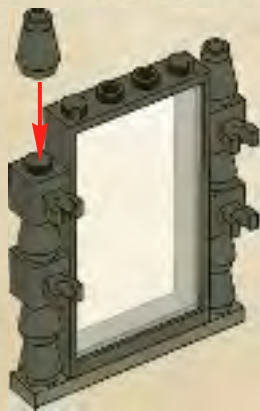

6

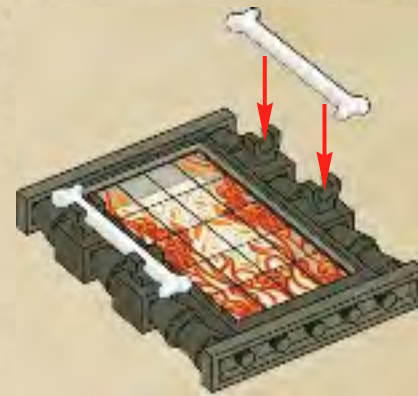

5

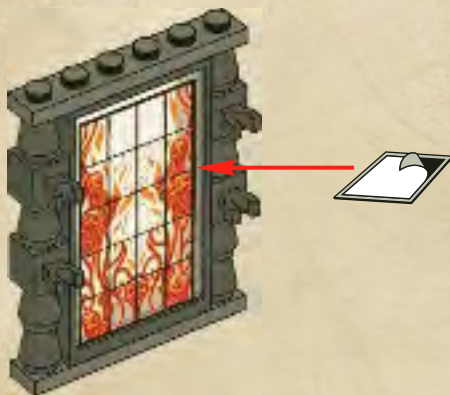

7



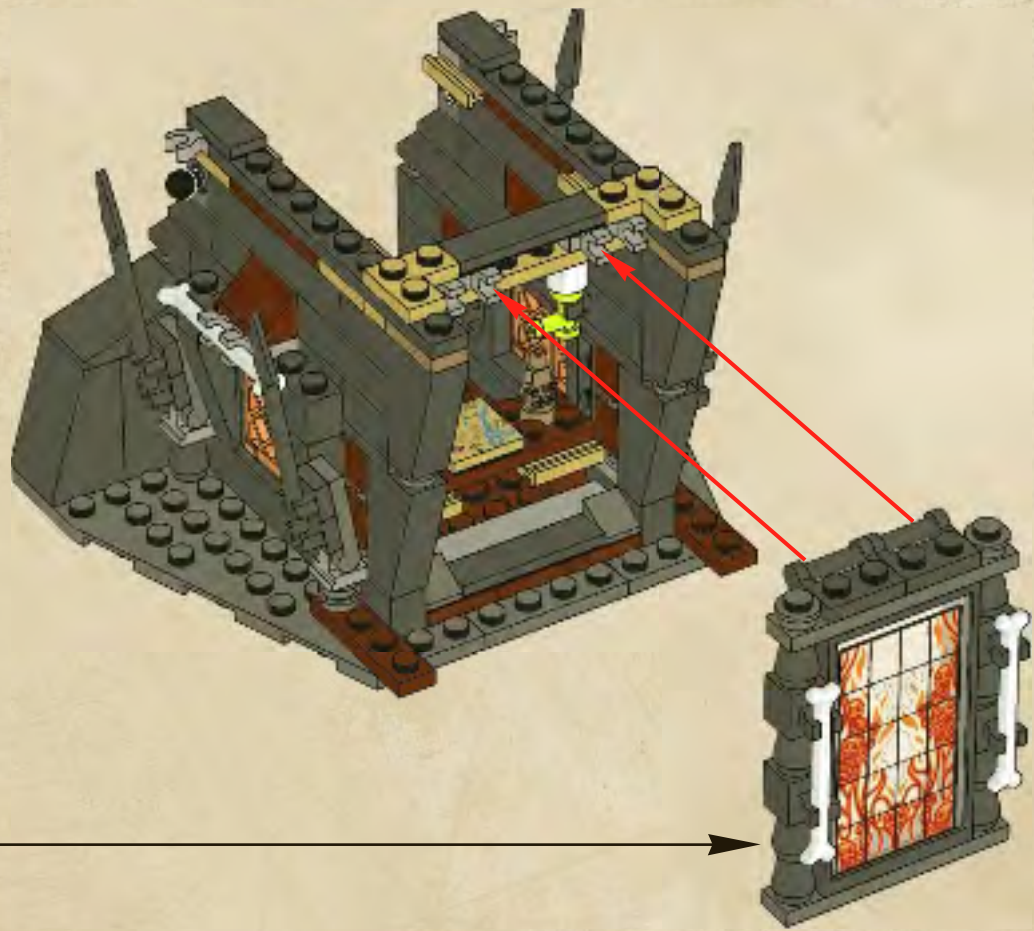

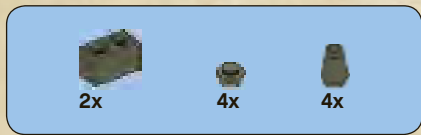

26

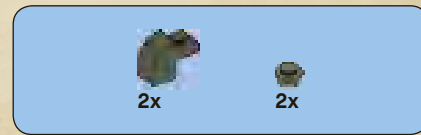
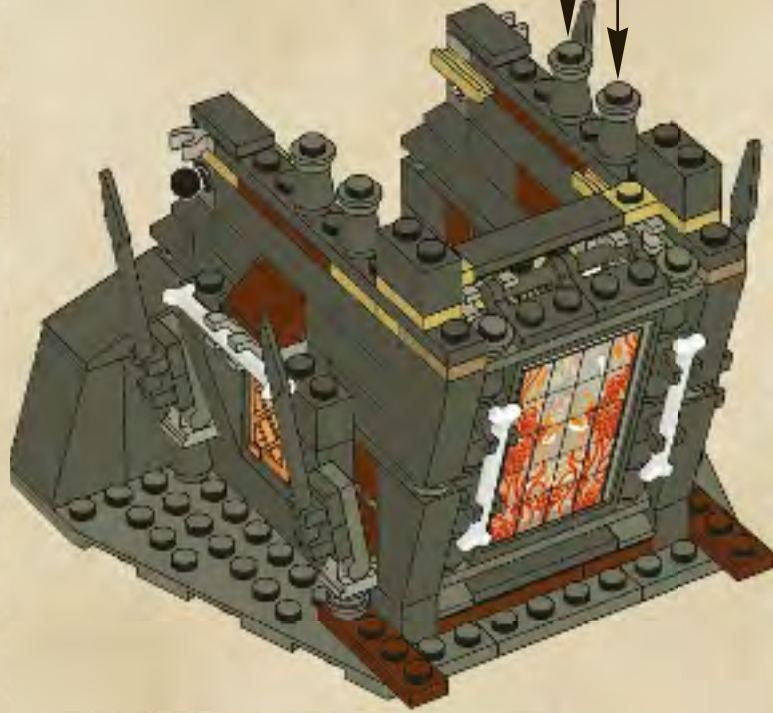
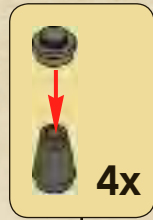

27

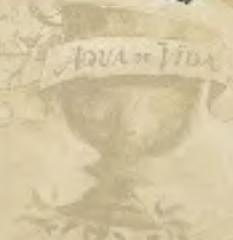
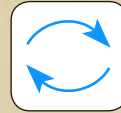

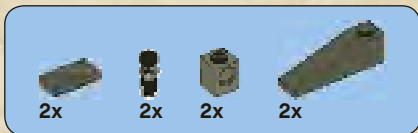

28

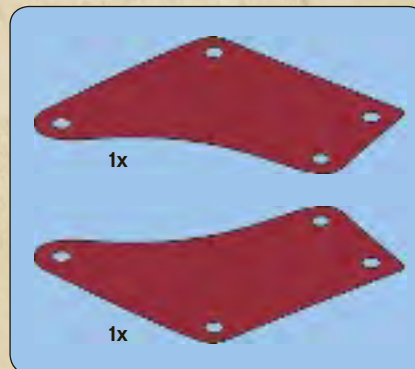

29

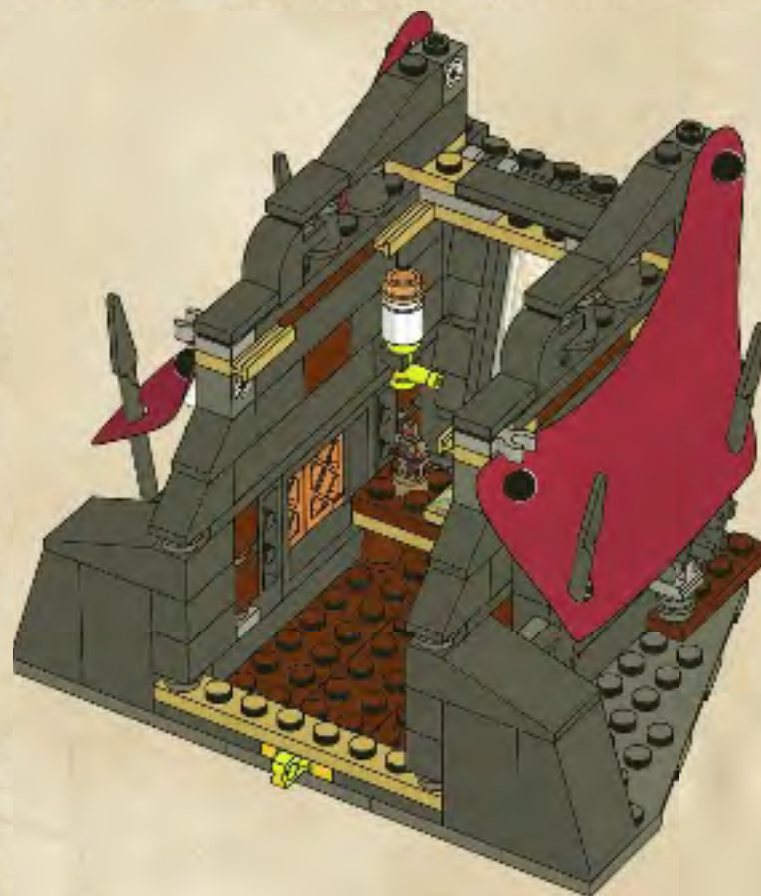

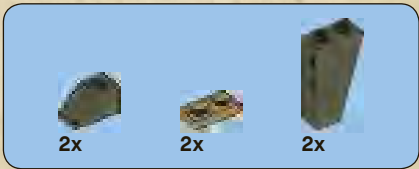

31

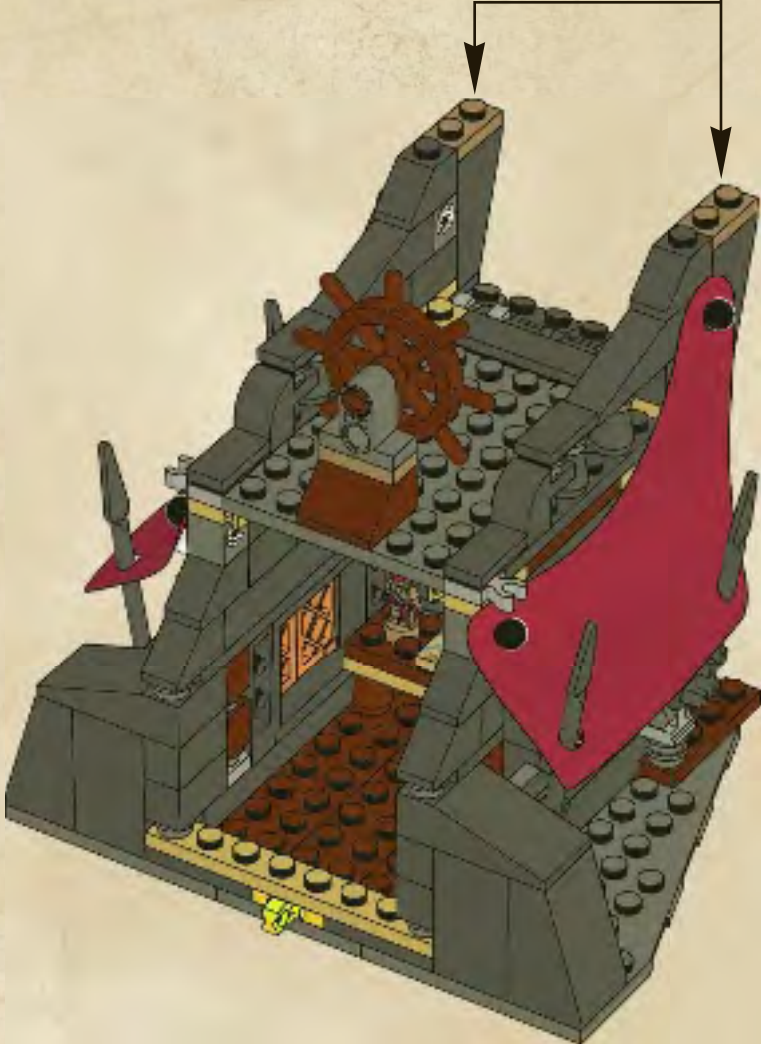
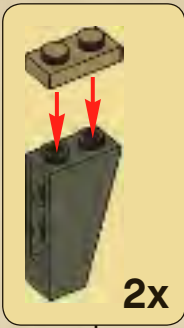

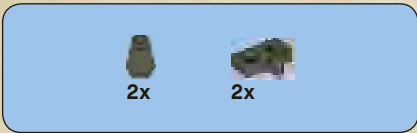

32

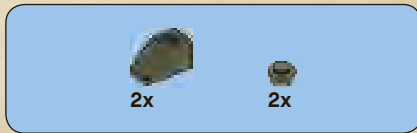
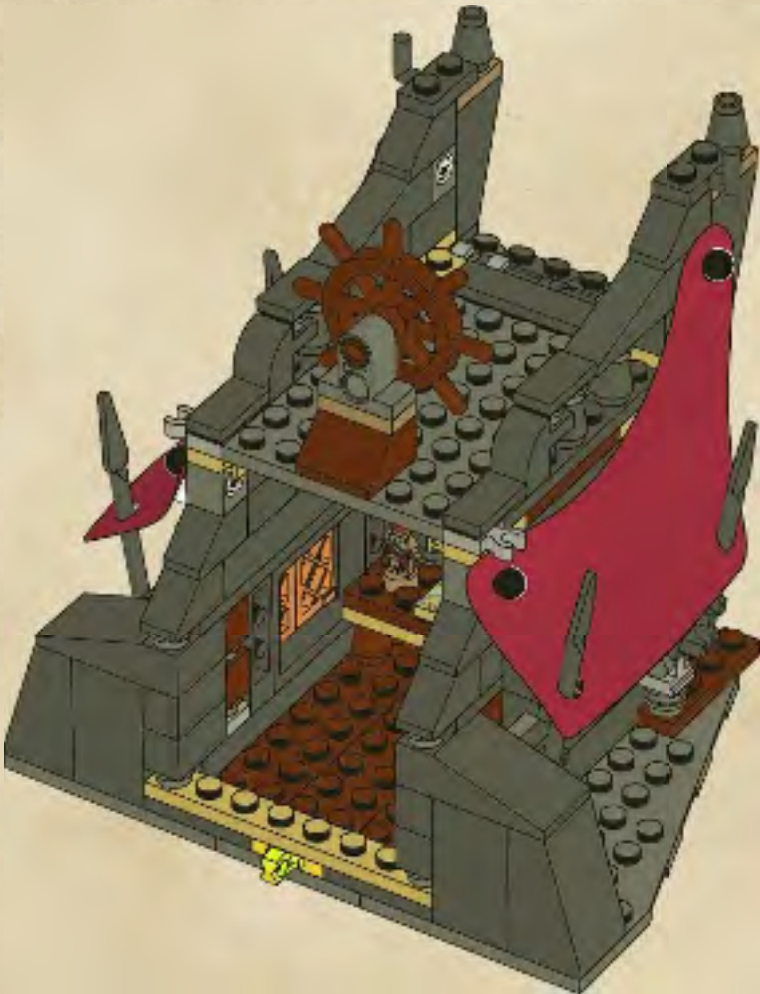

33

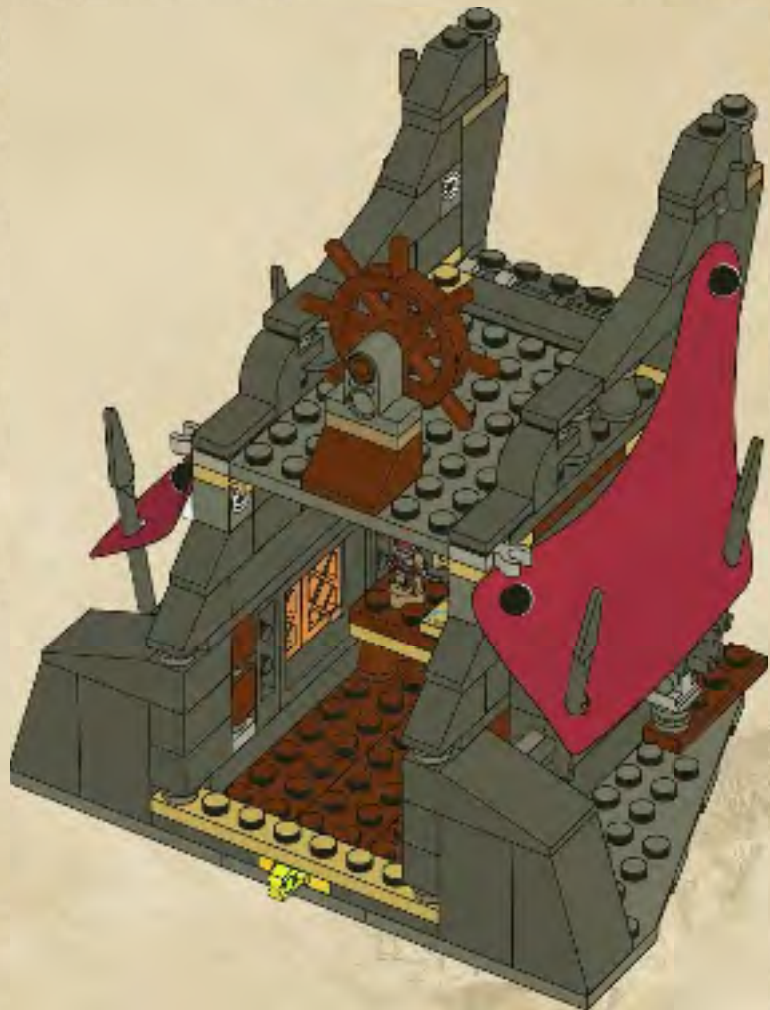



2x



2x

34



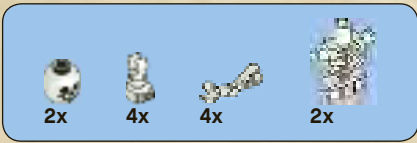

35

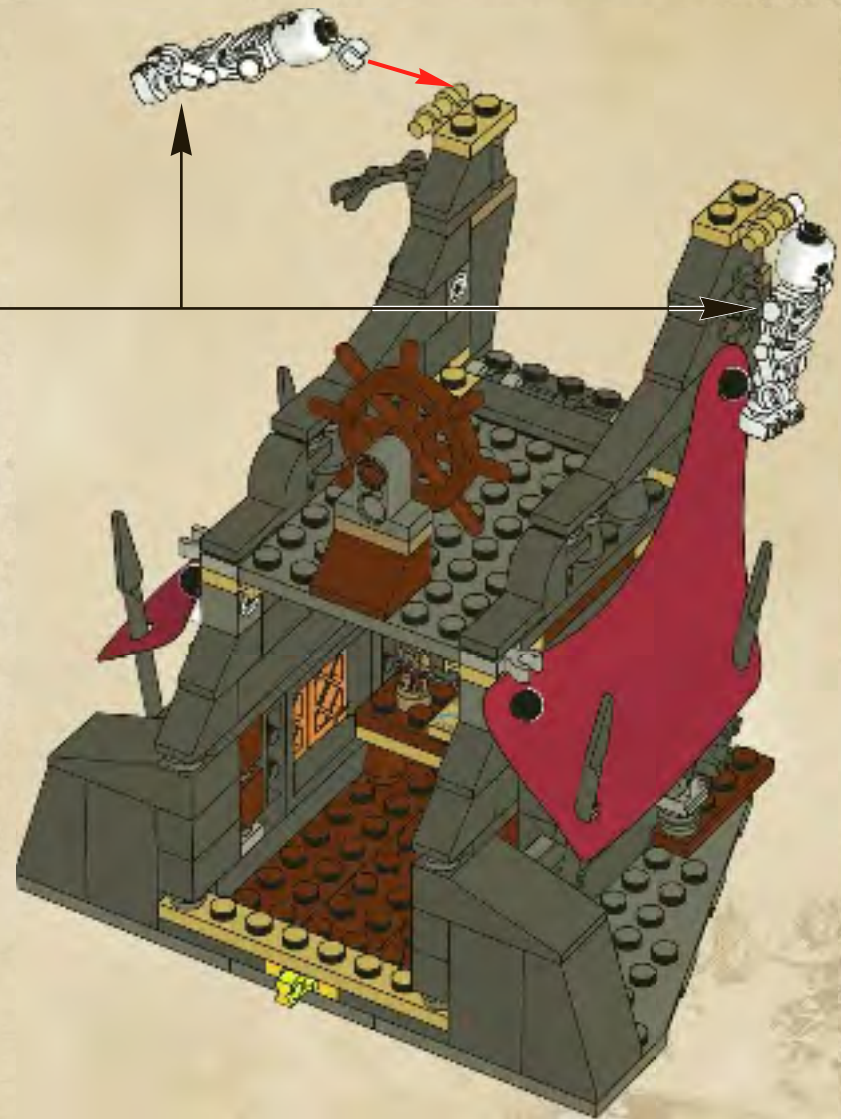
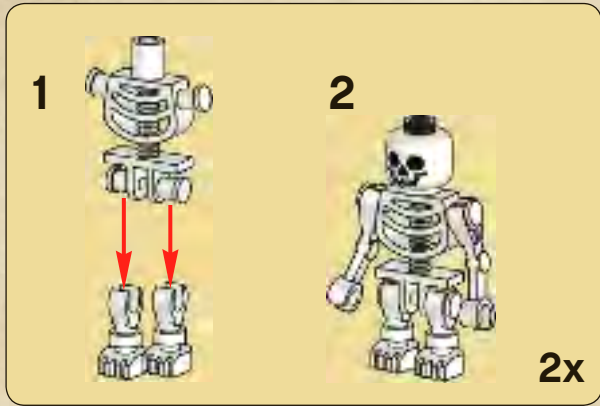



36

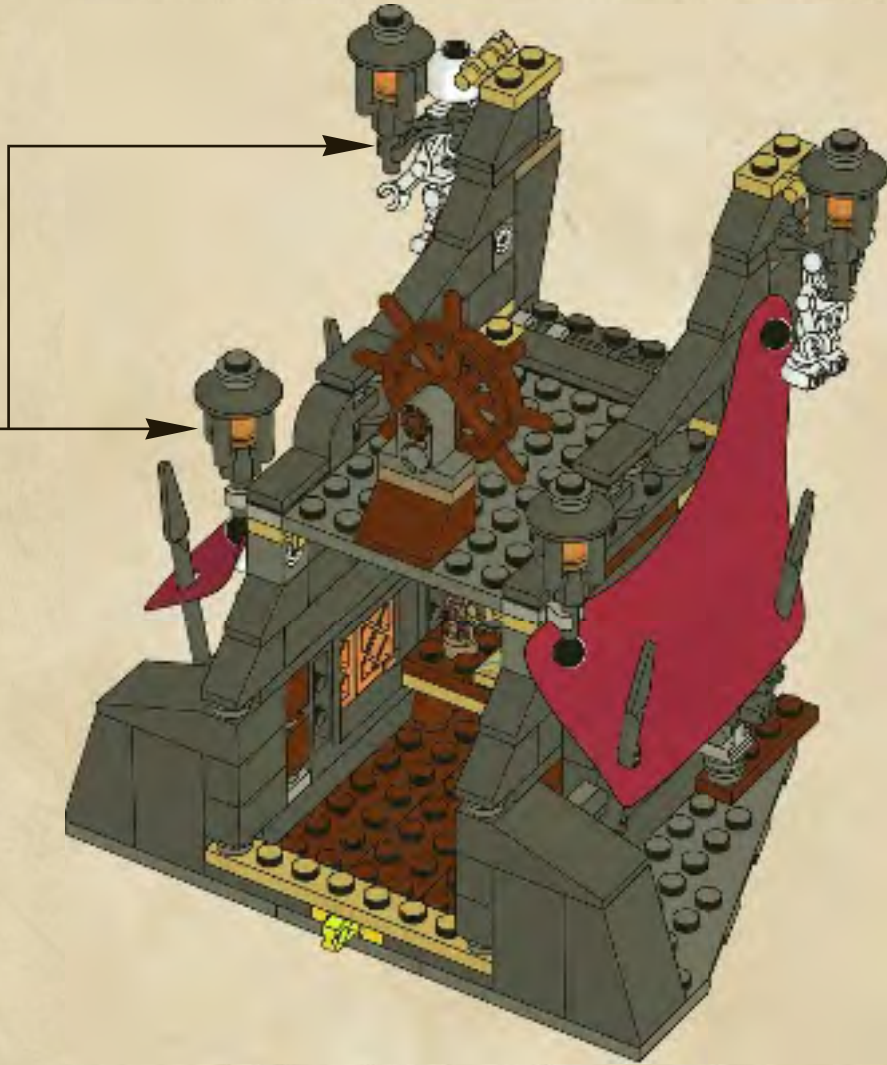



37

1

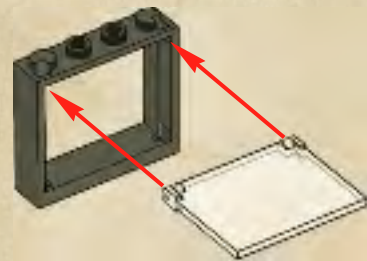

2



3

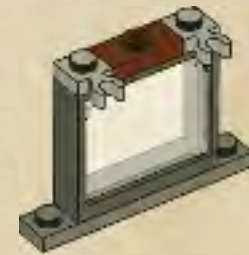

4

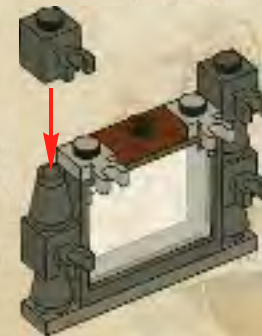

5

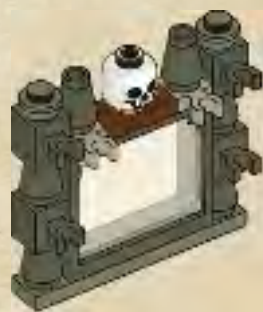

7

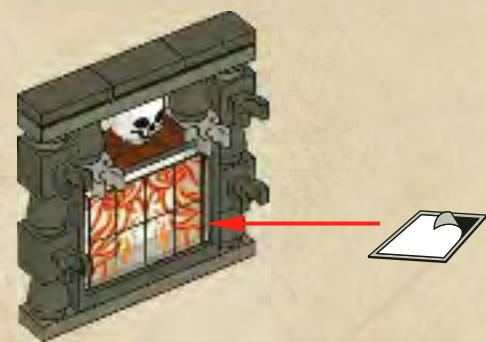

6

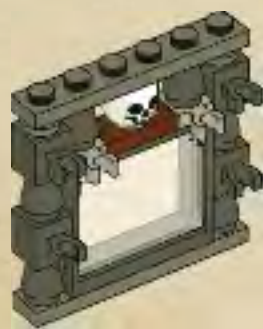

8





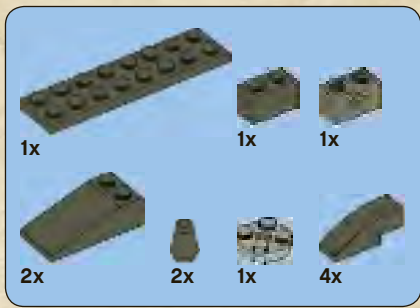

38

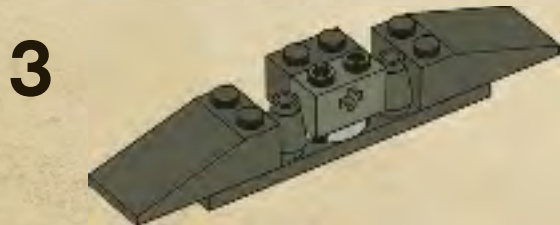
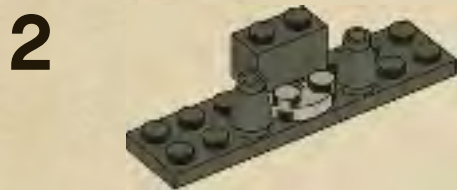
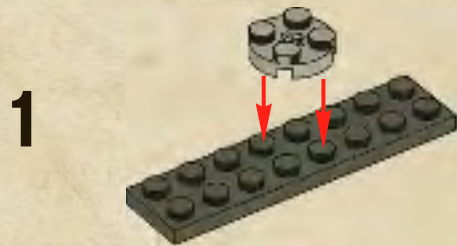

4

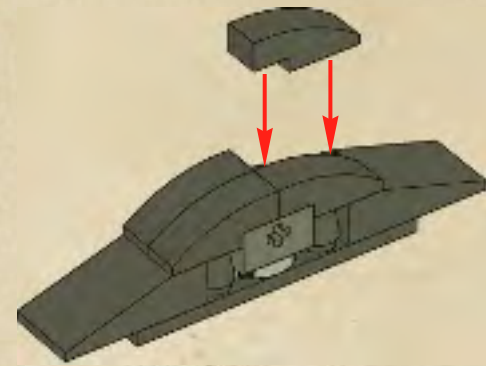

39

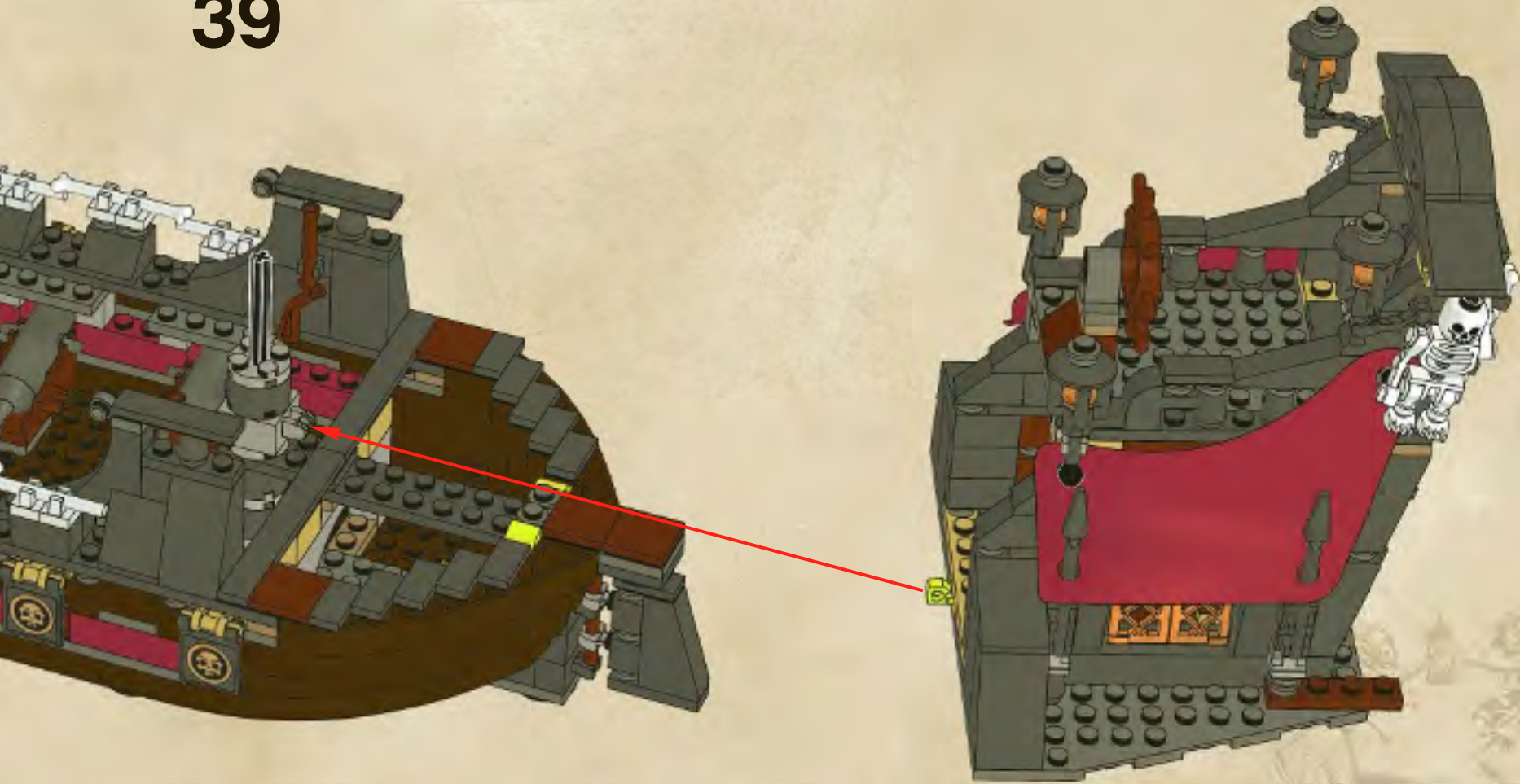



1

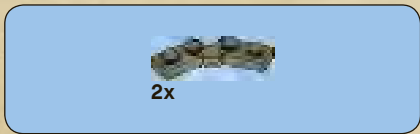
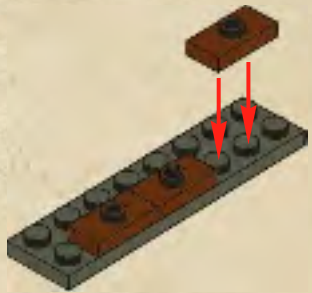

2



3

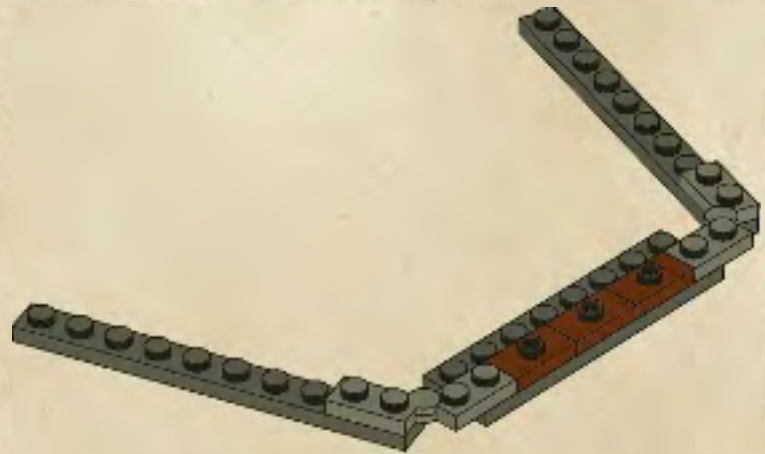



8x

4

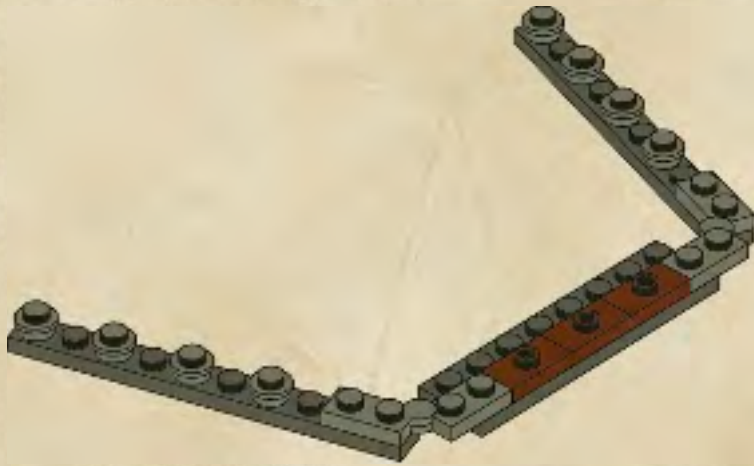

5x

5





10x

6

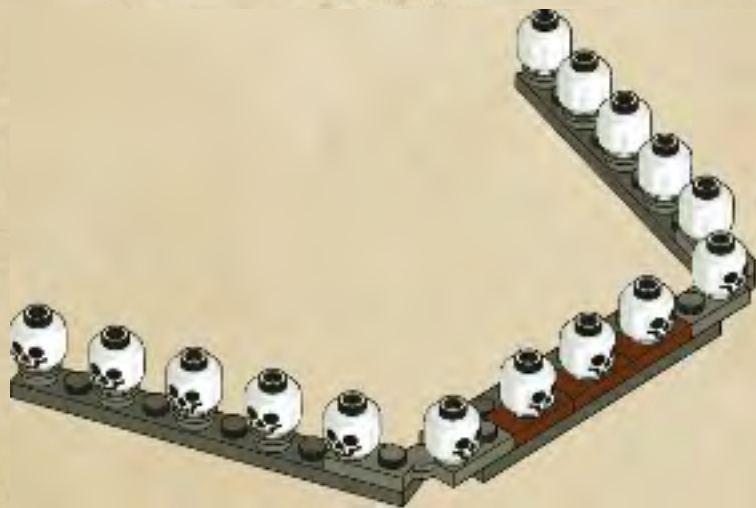

1x



2x

7

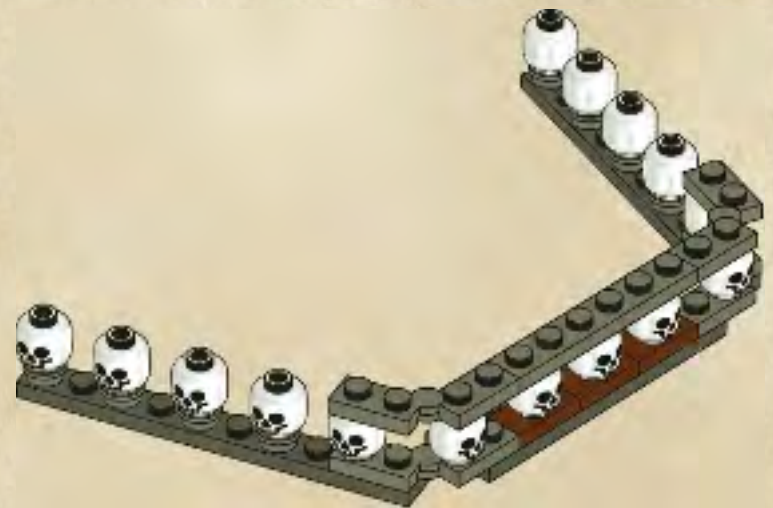

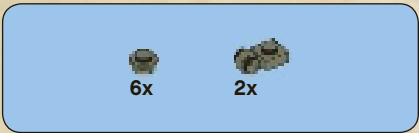

8

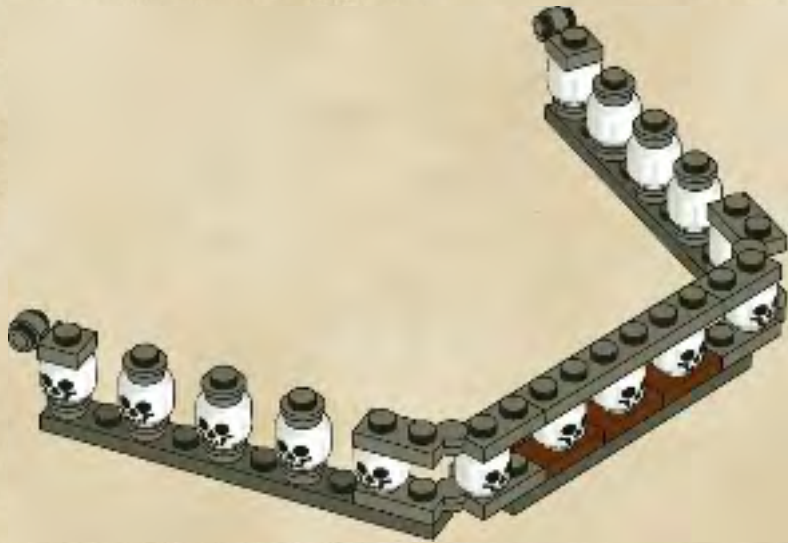

9





6x

10

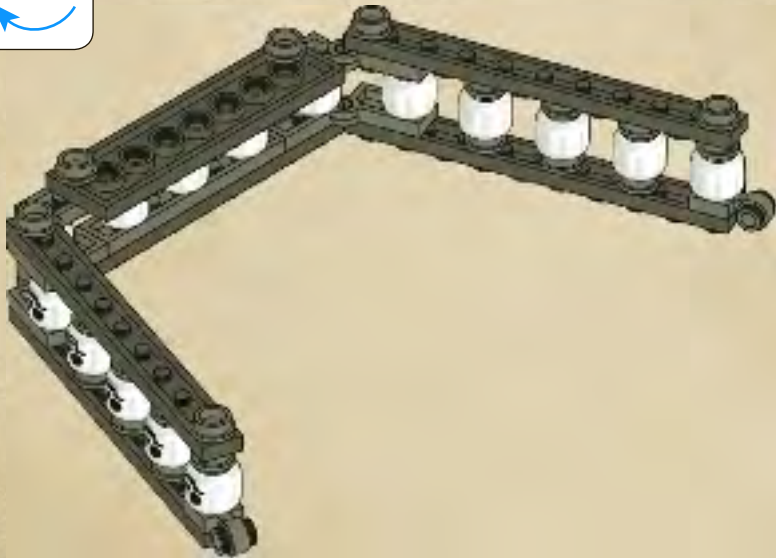

2x



2x

11

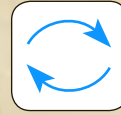

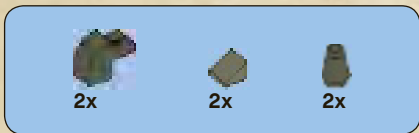

12

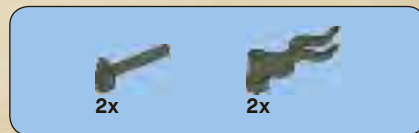
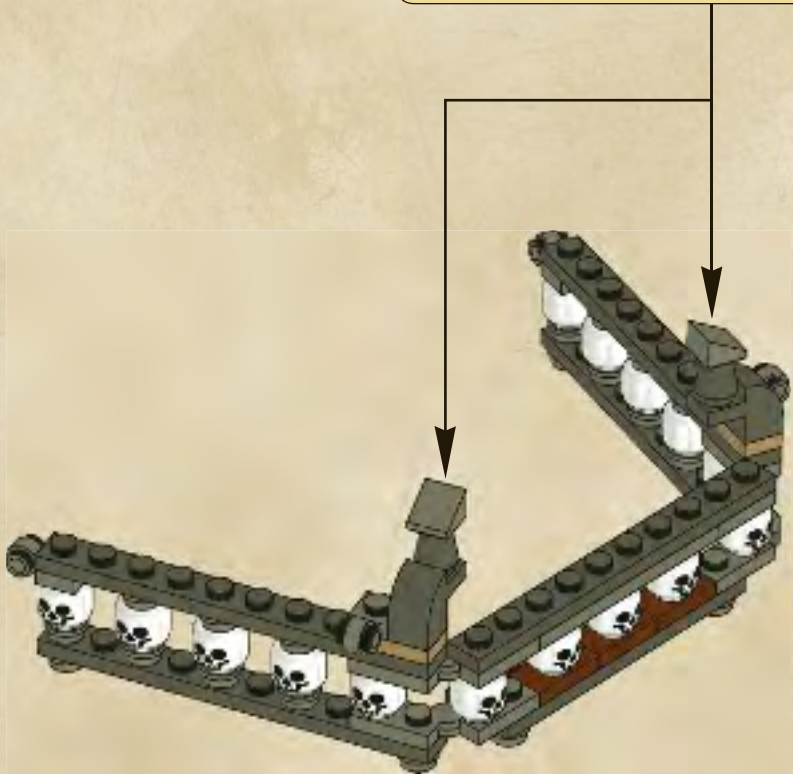

13

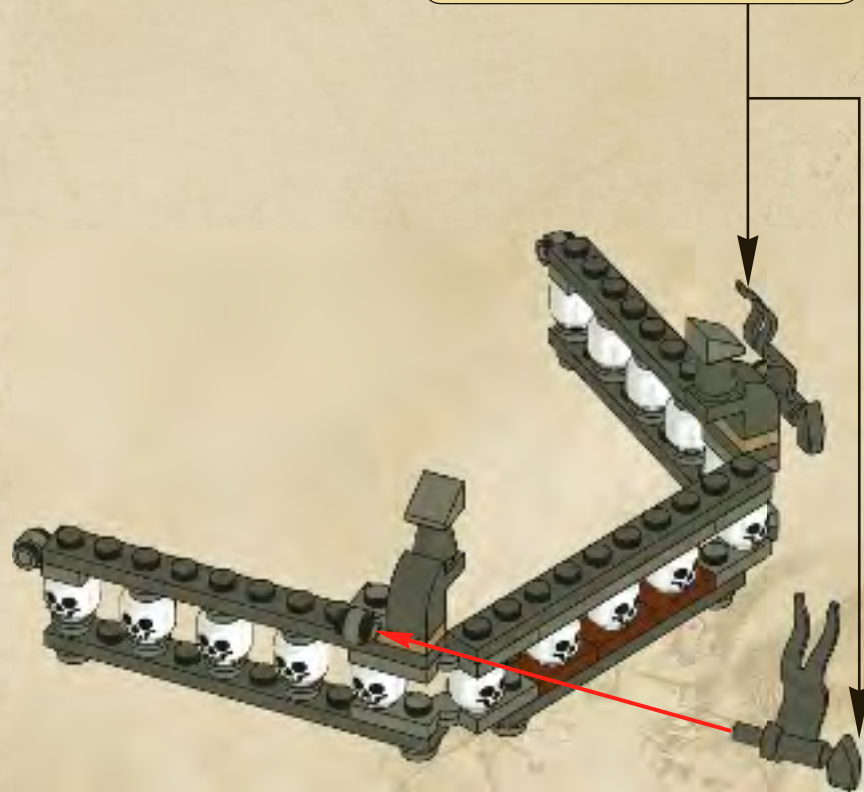

40

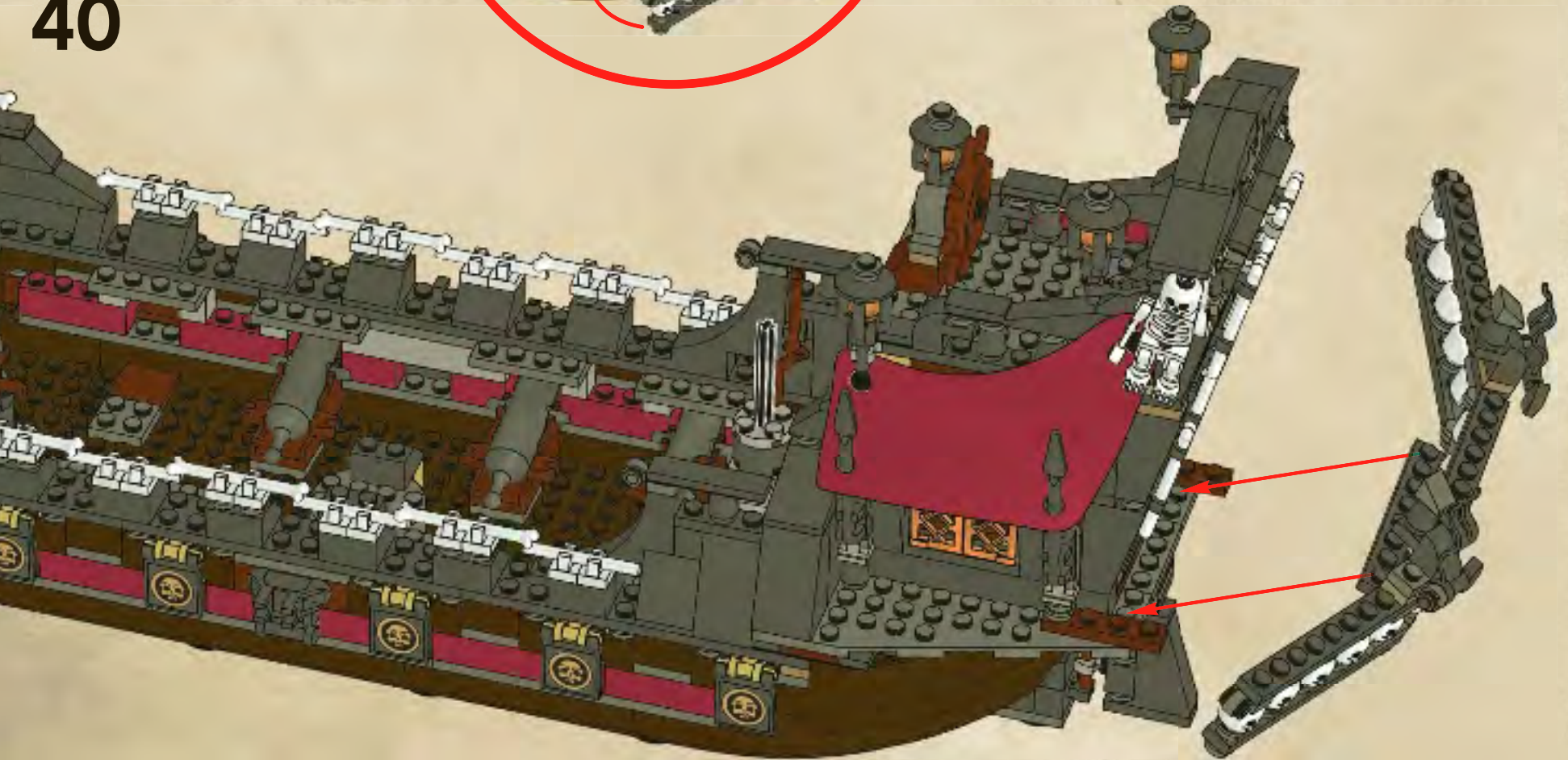
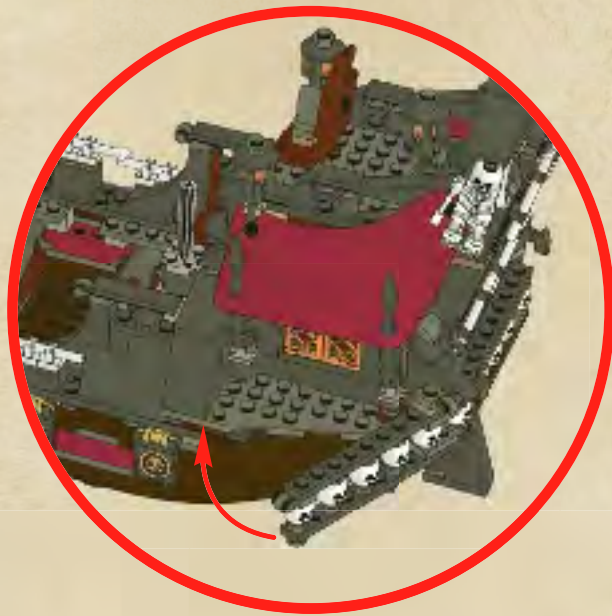

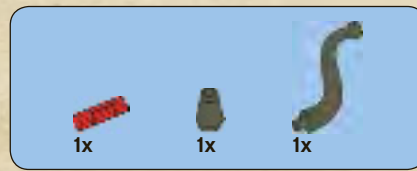
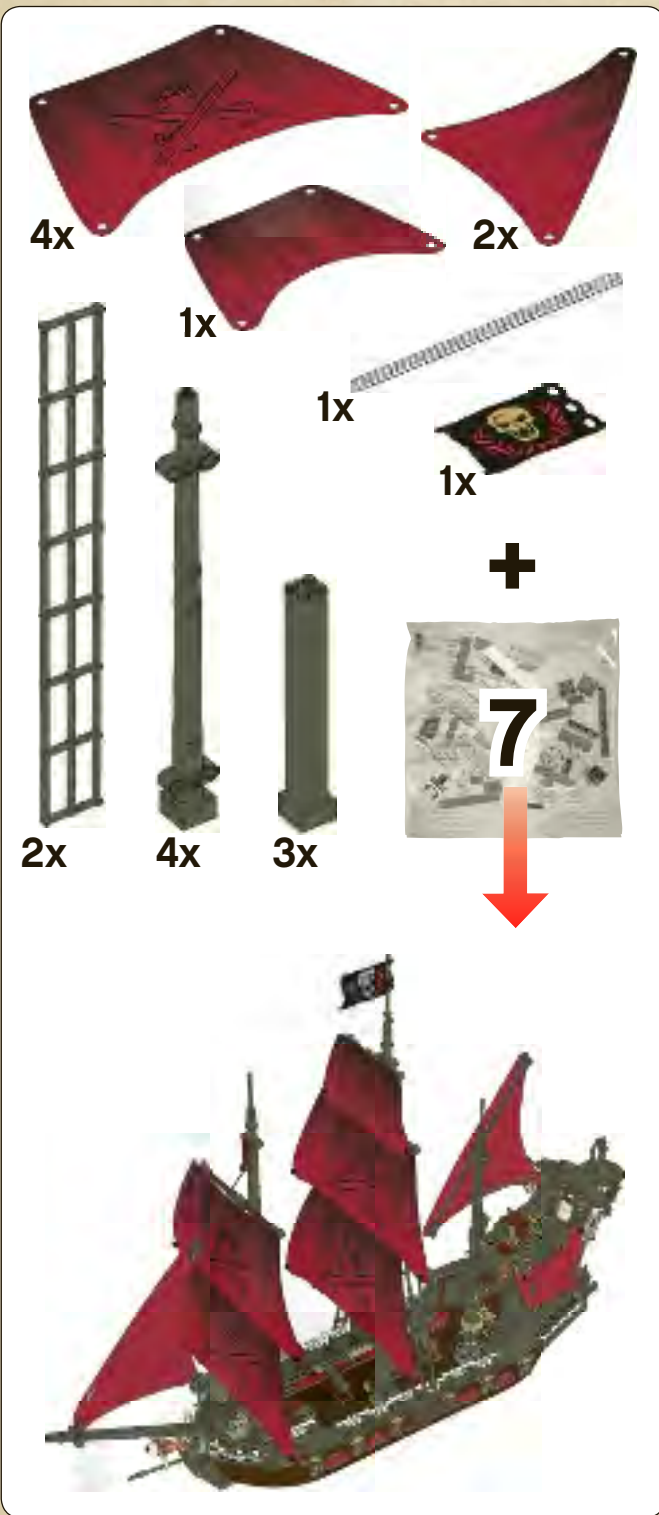

41

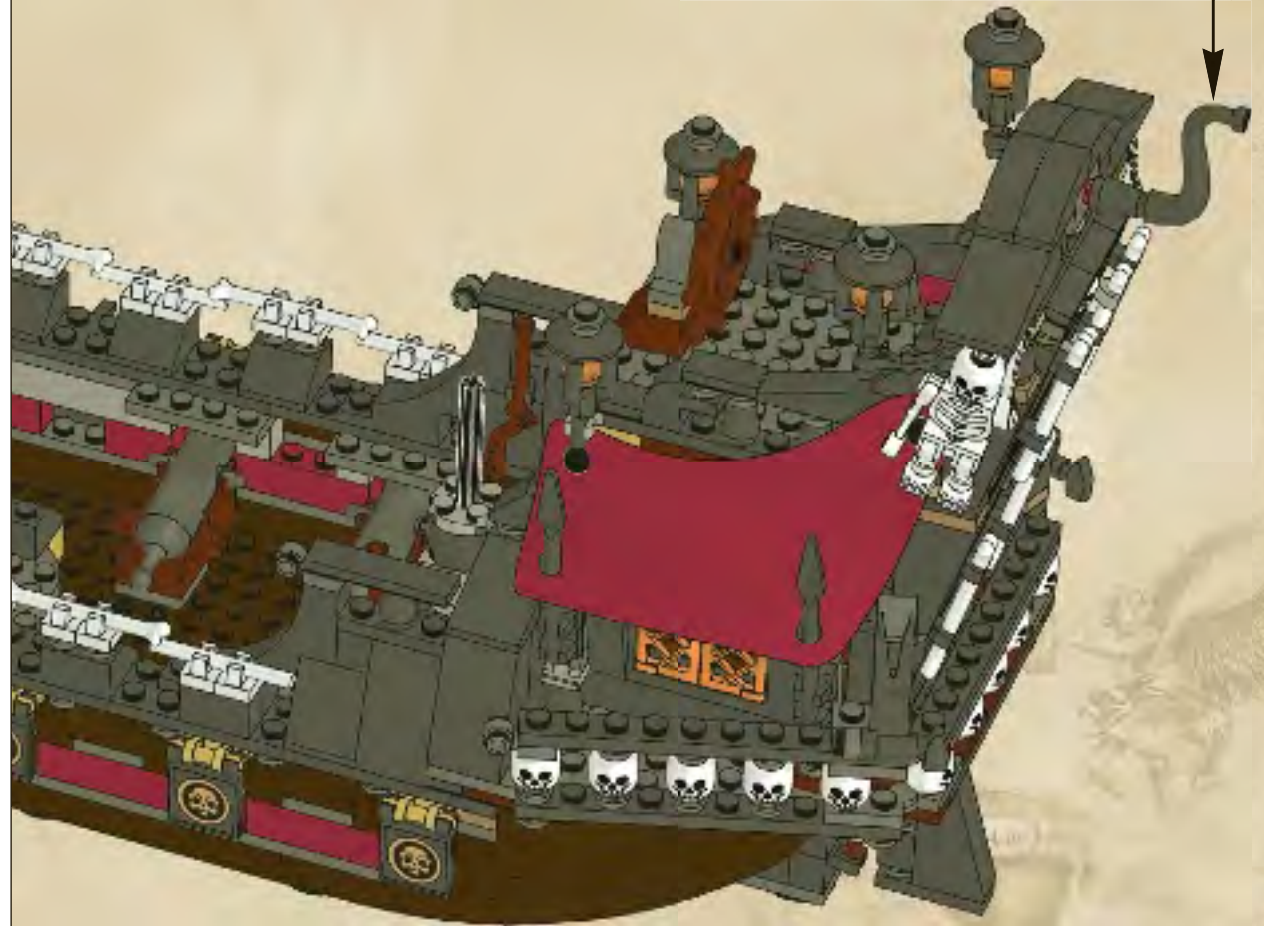
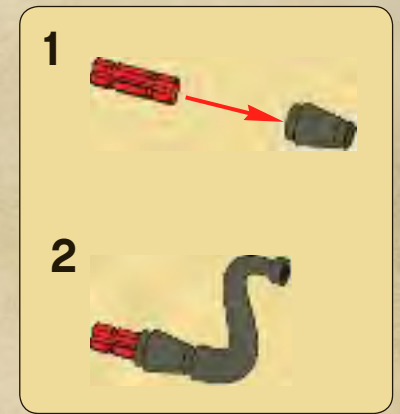



1

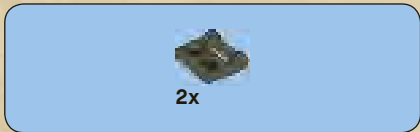

2

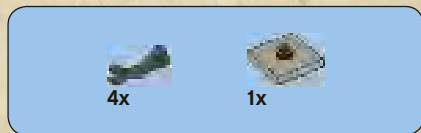
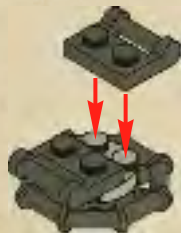

3

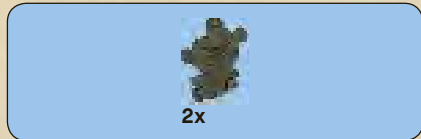

4

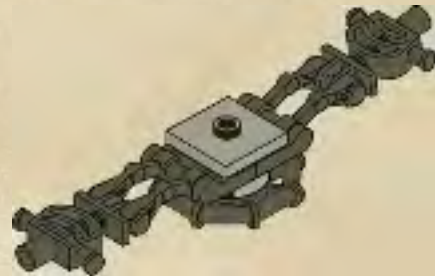

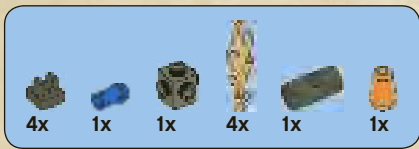

5



6



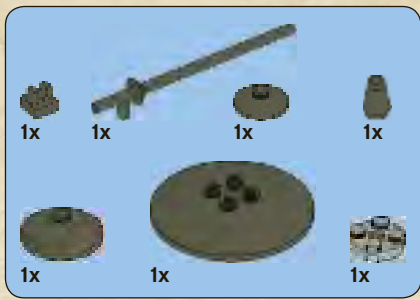

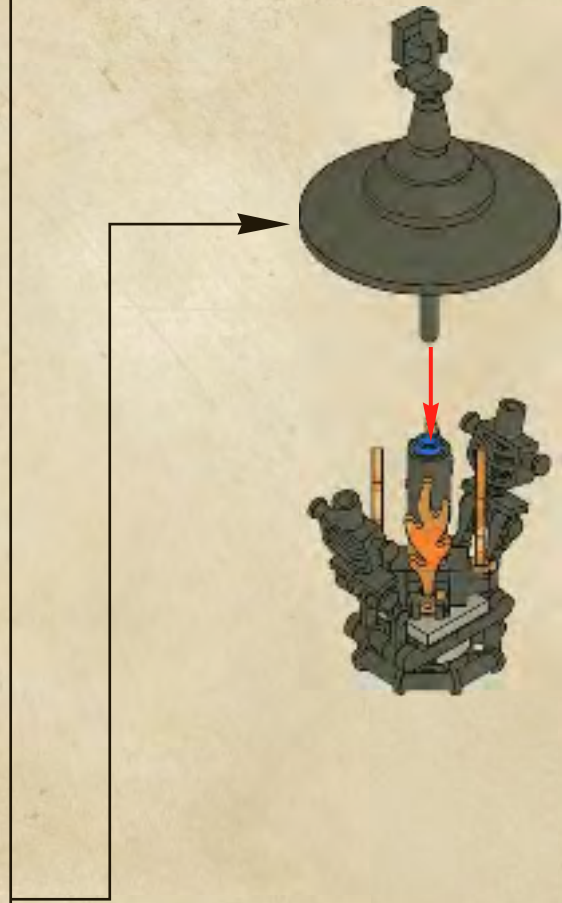
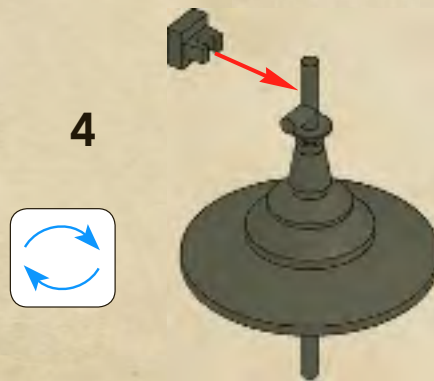
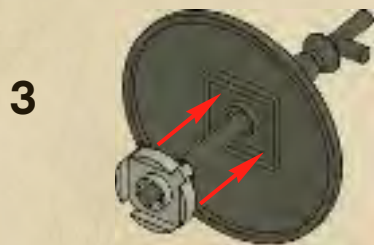

7

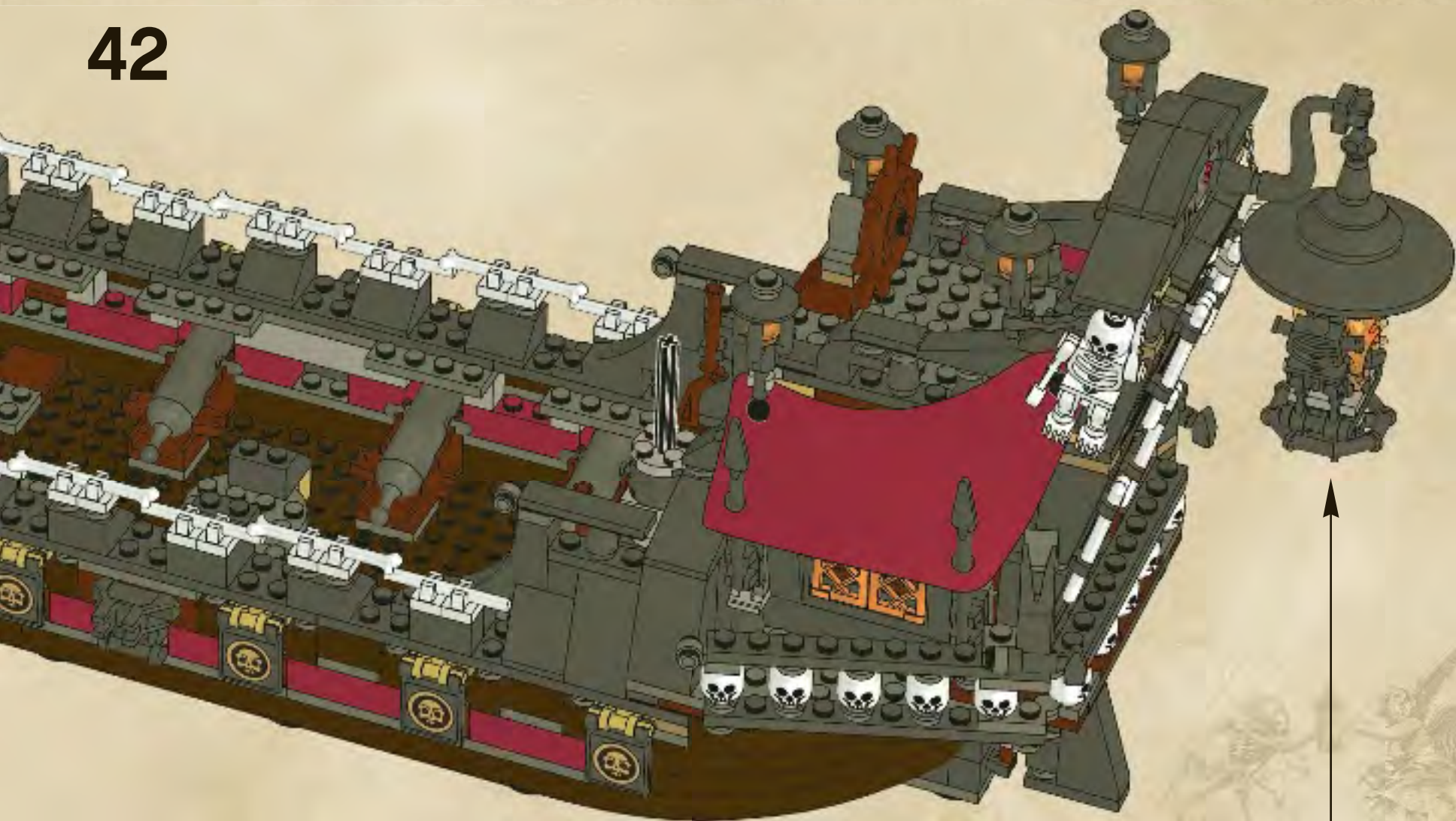

42



2x  1x 

43

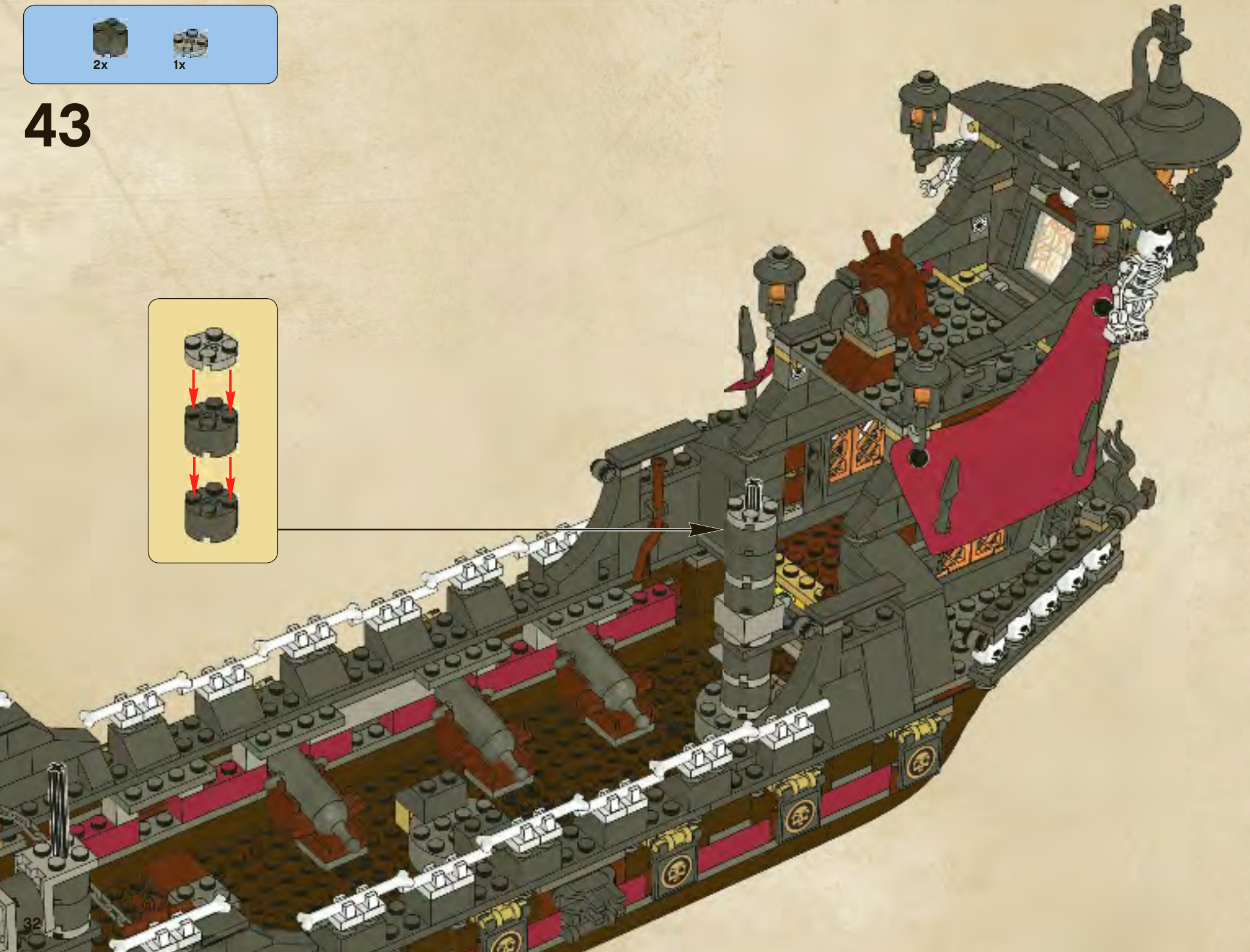
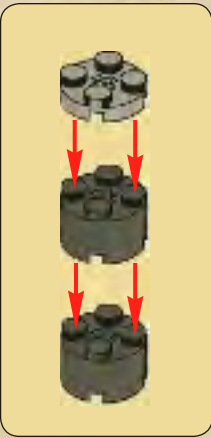

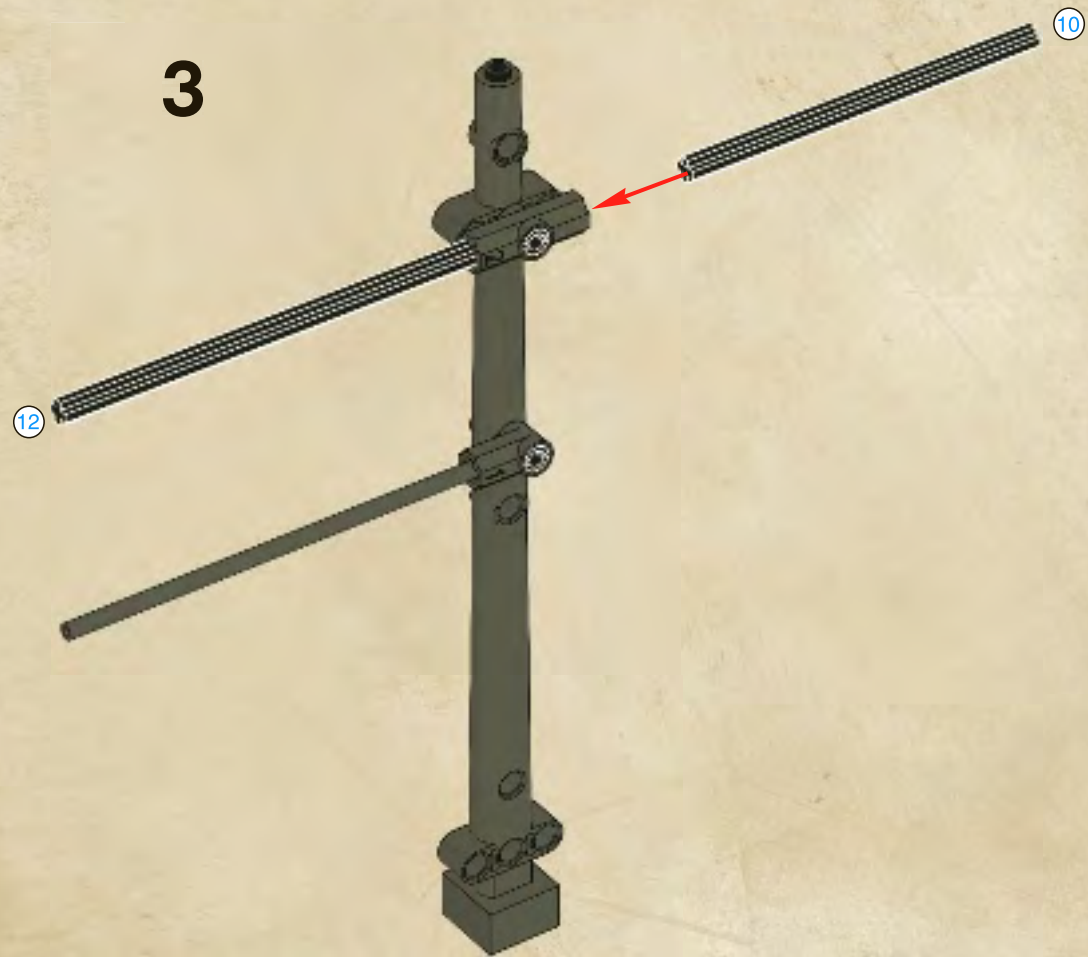



6



7



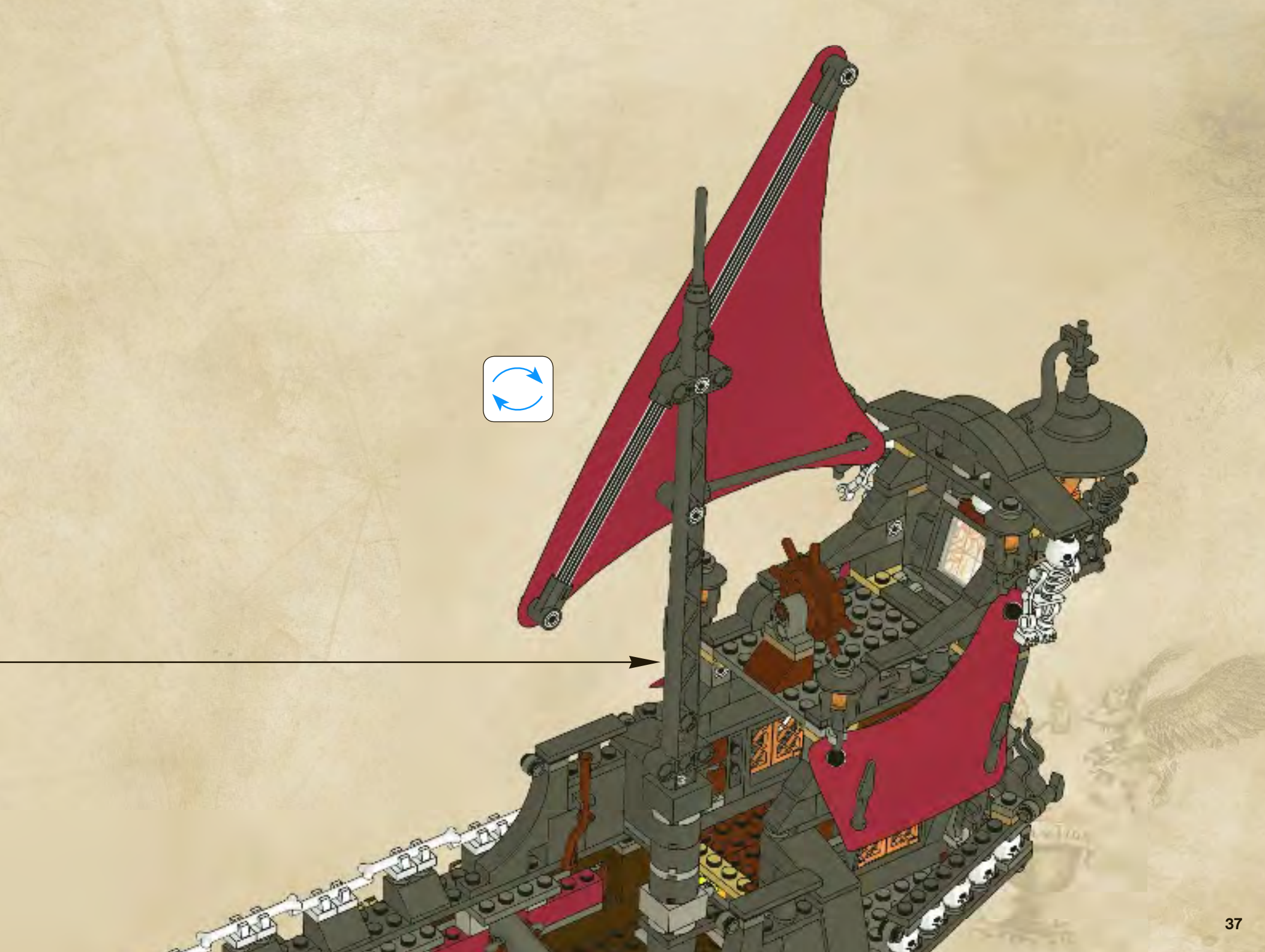

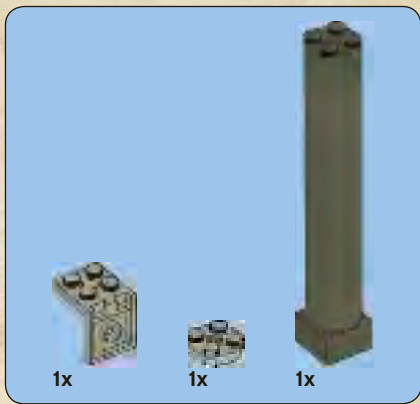

45



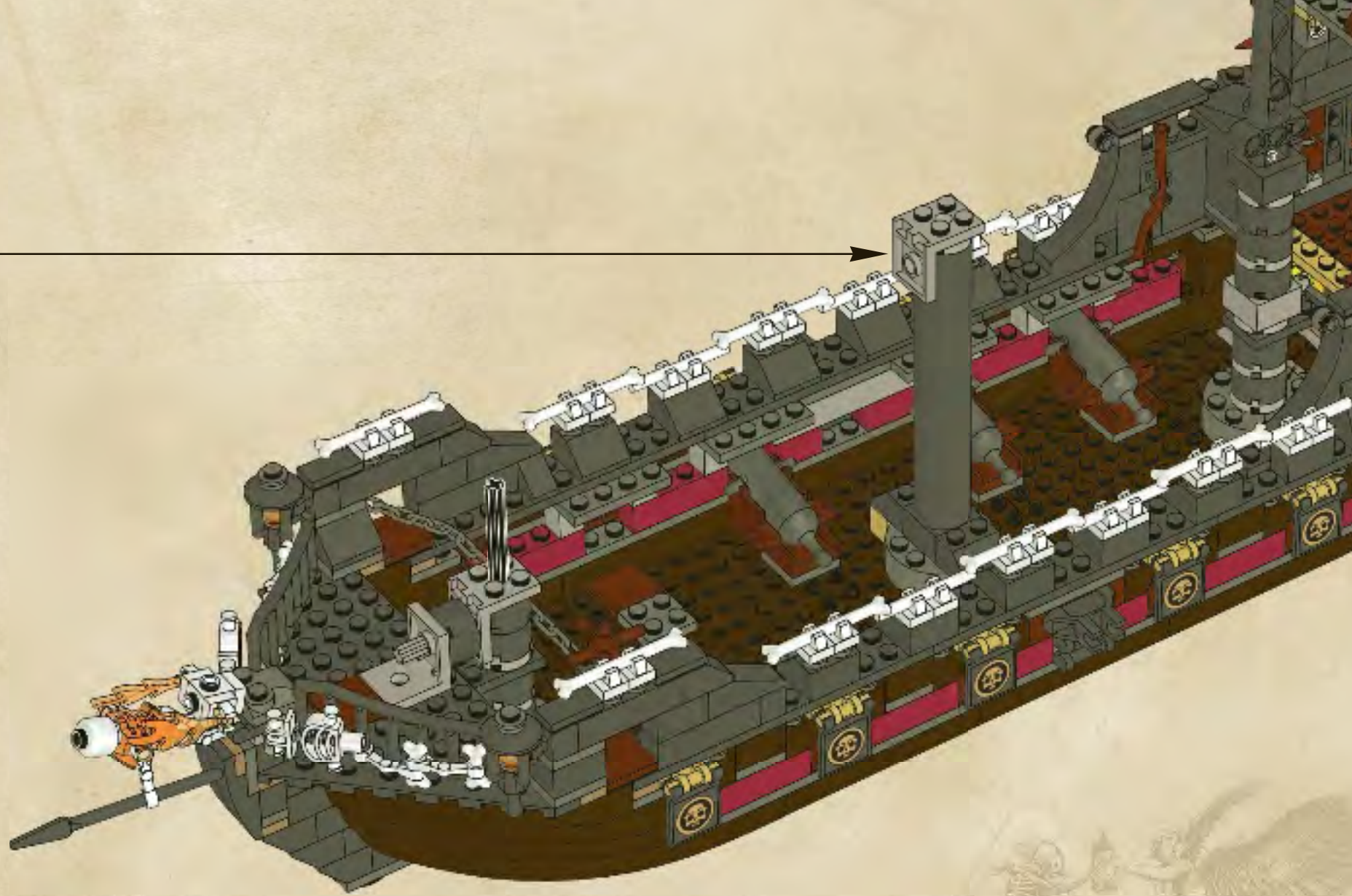

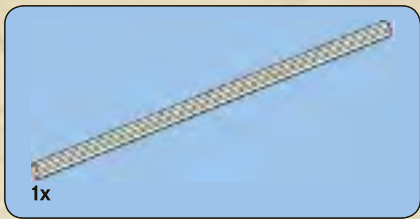

46

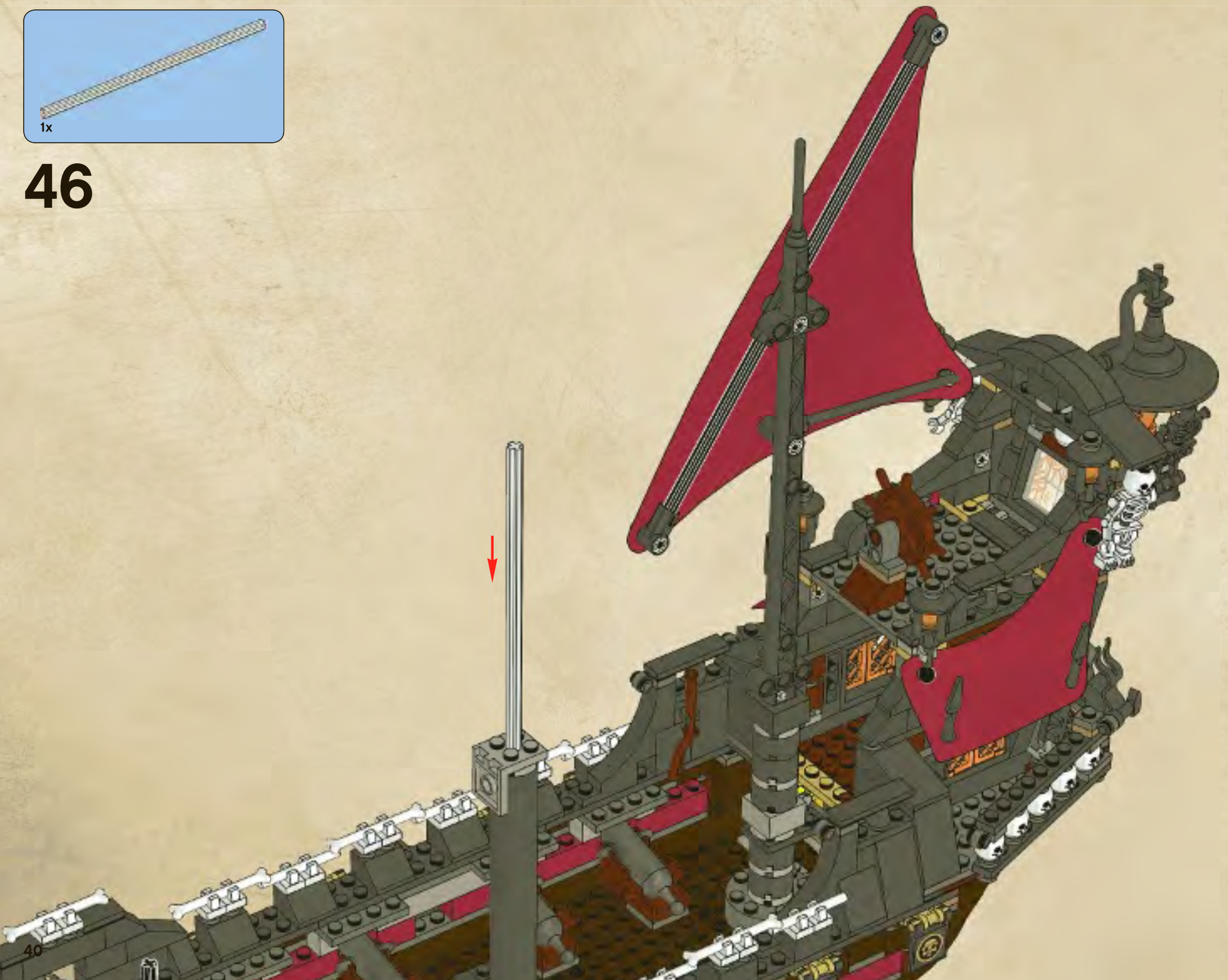

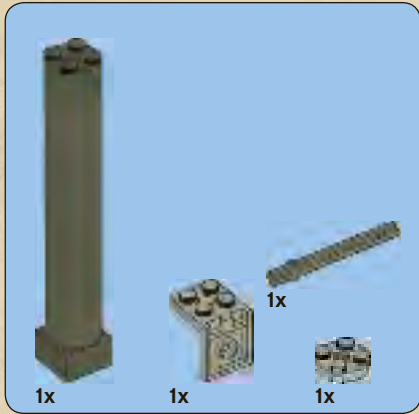

47

1



2



3

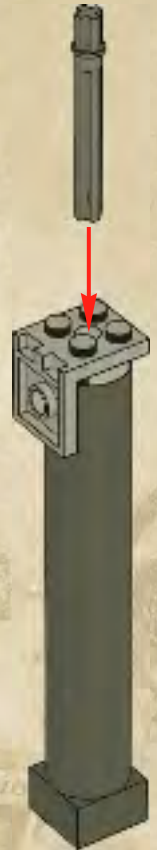

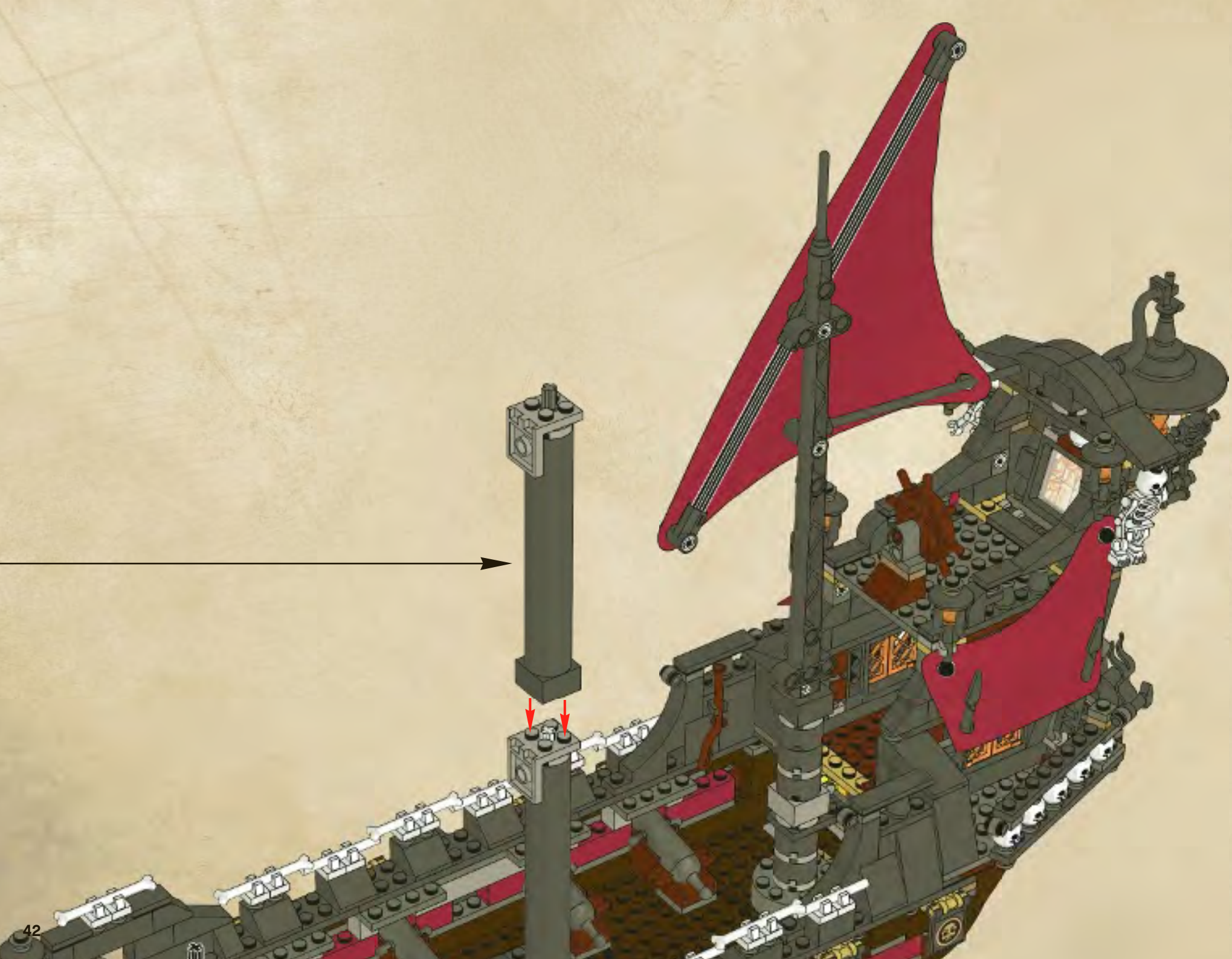

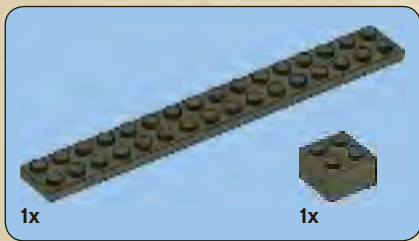

48

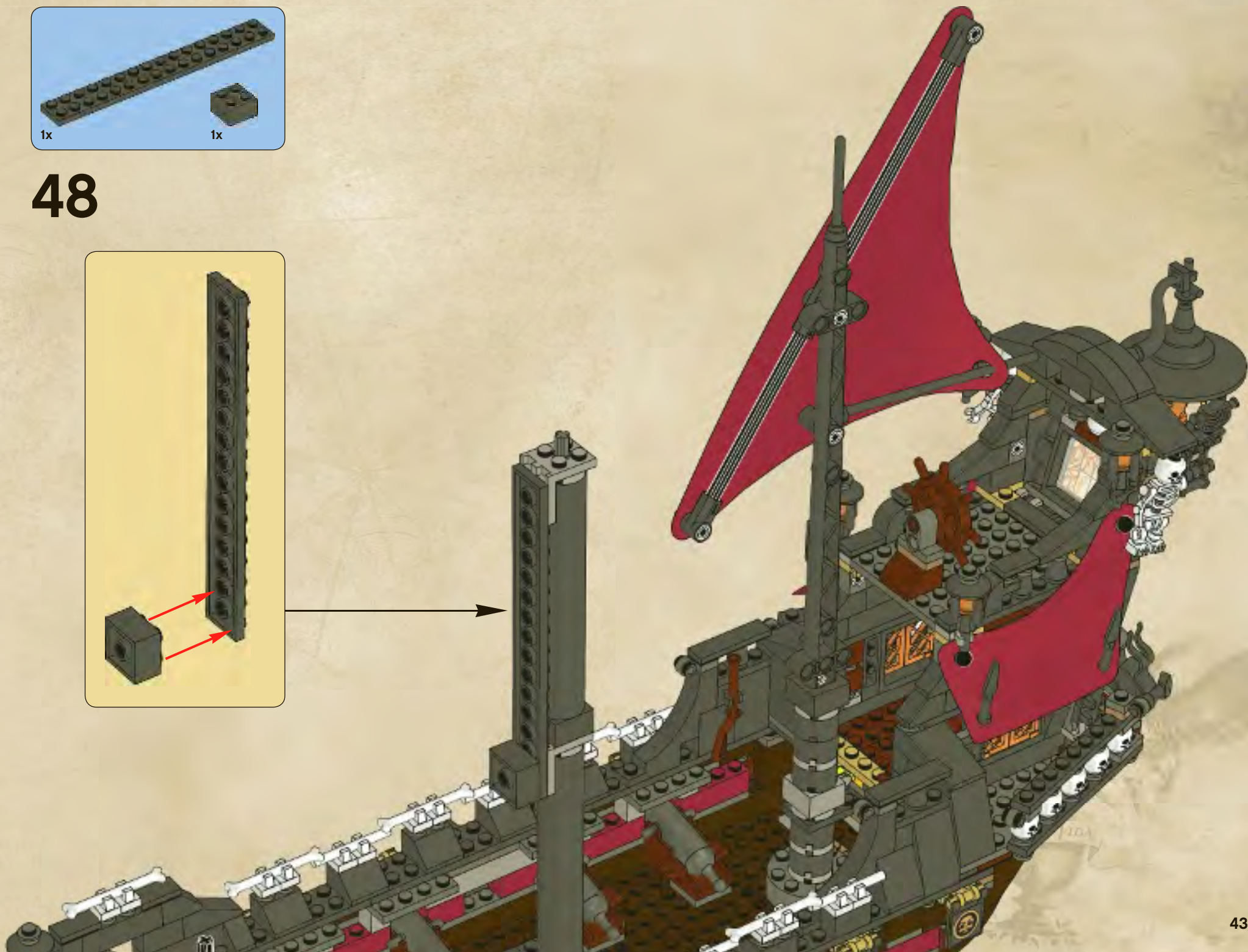

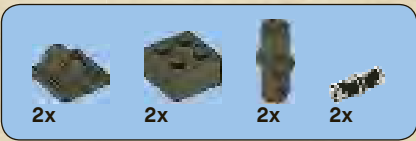

49

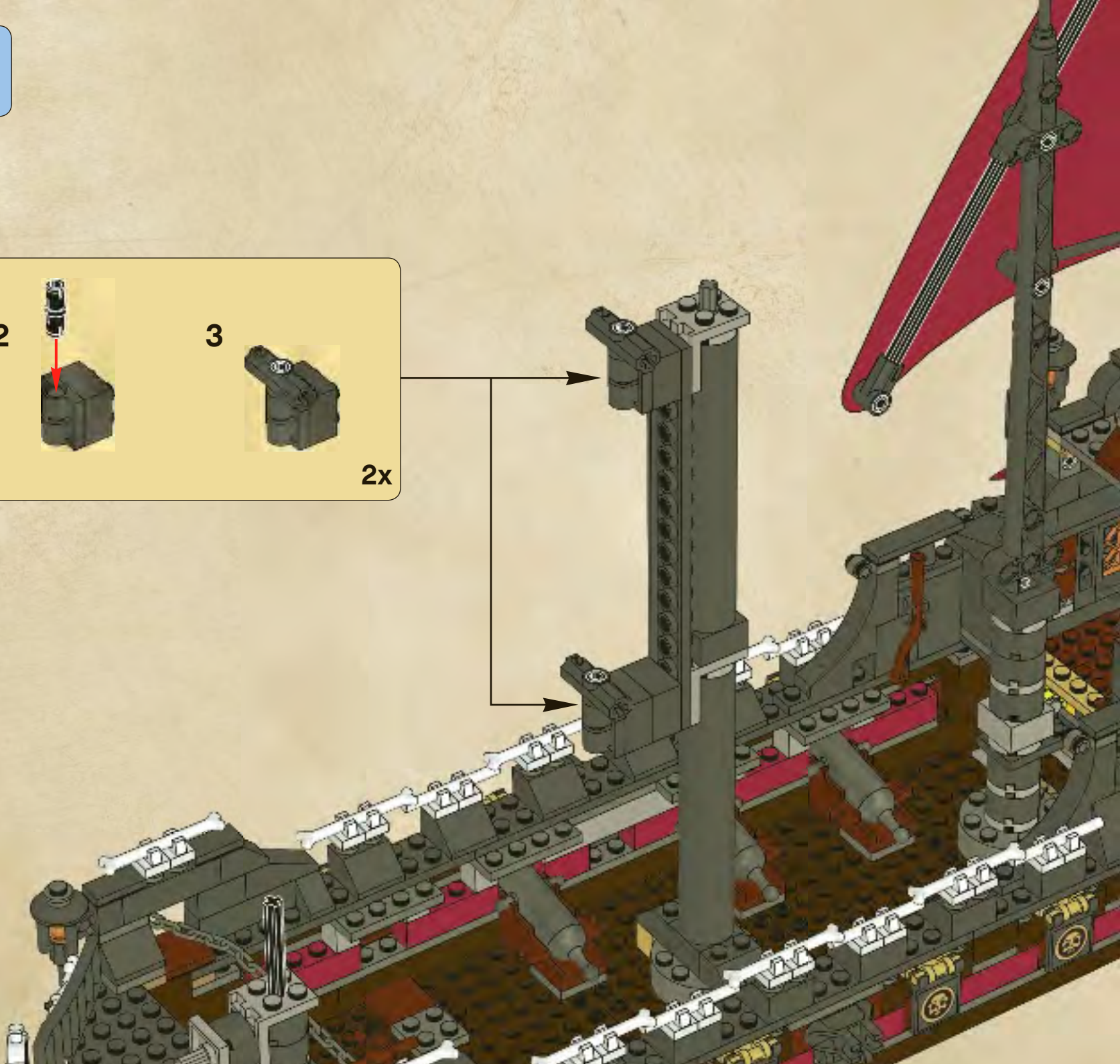

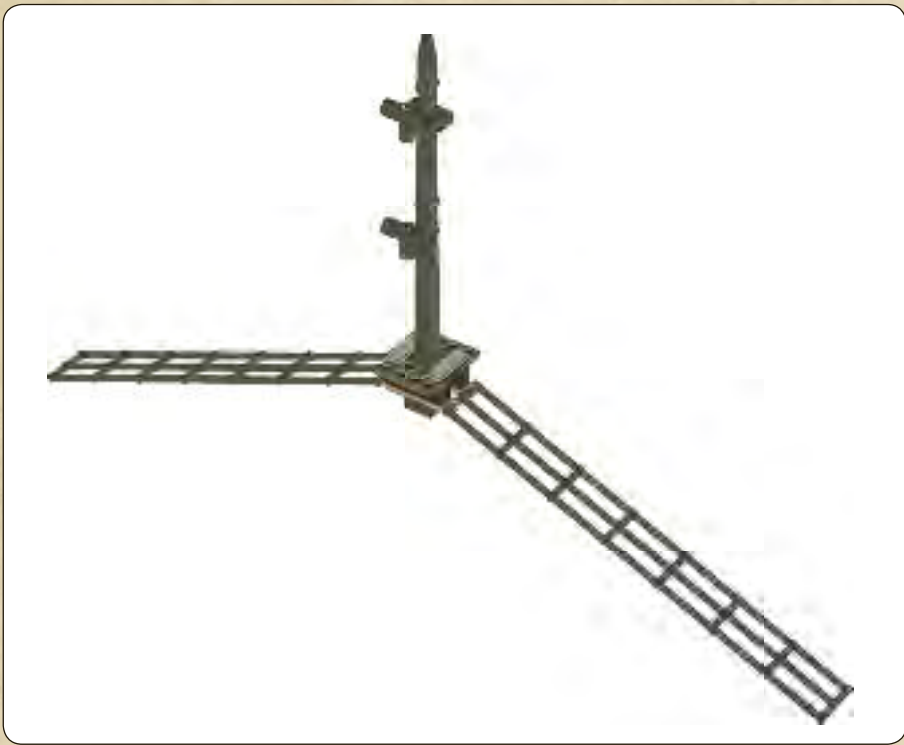

1



2

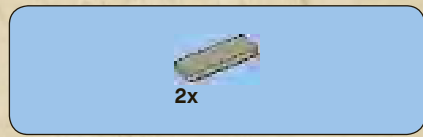
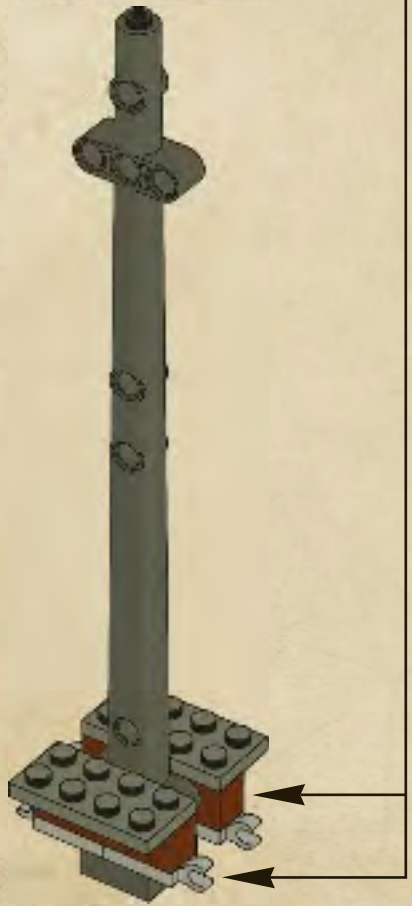
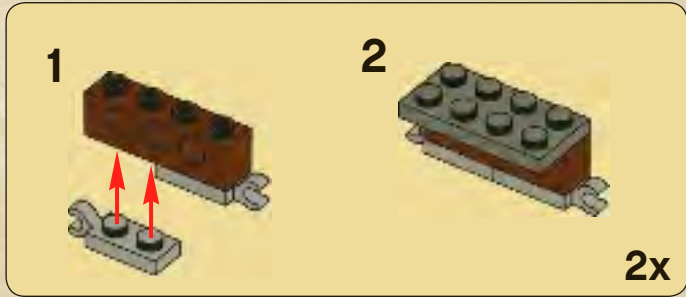

3



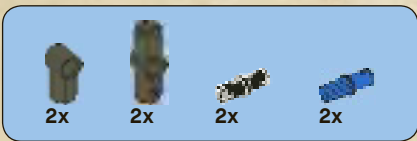

4

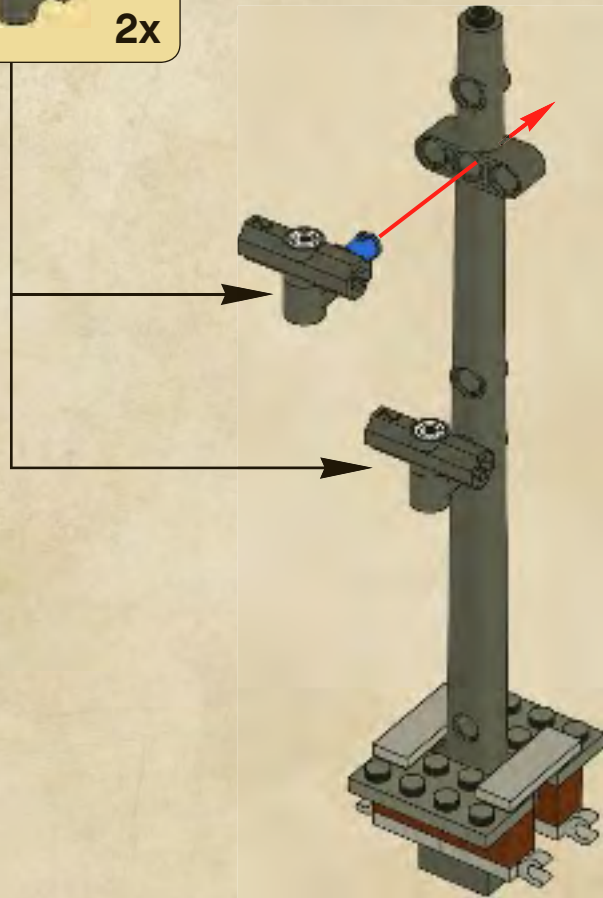

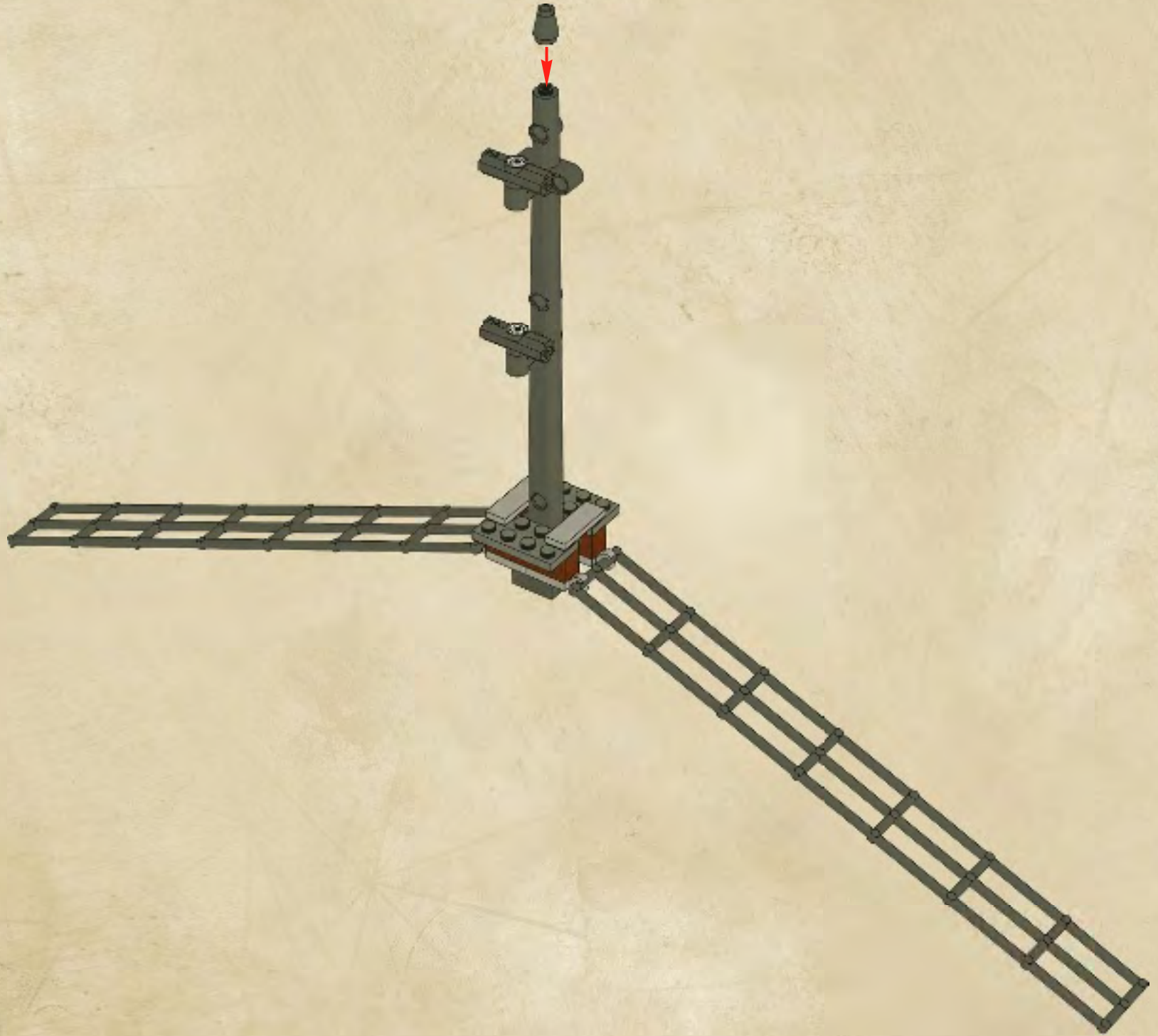
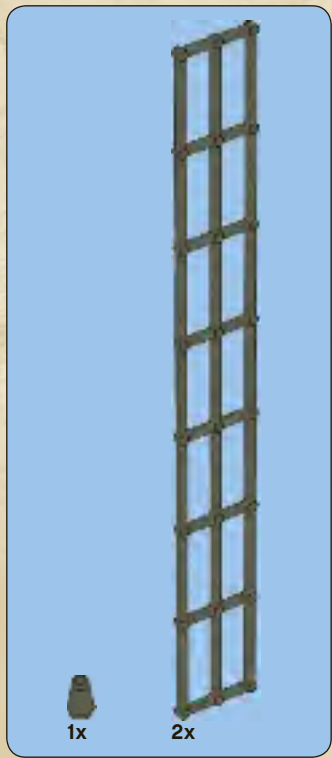

5

50

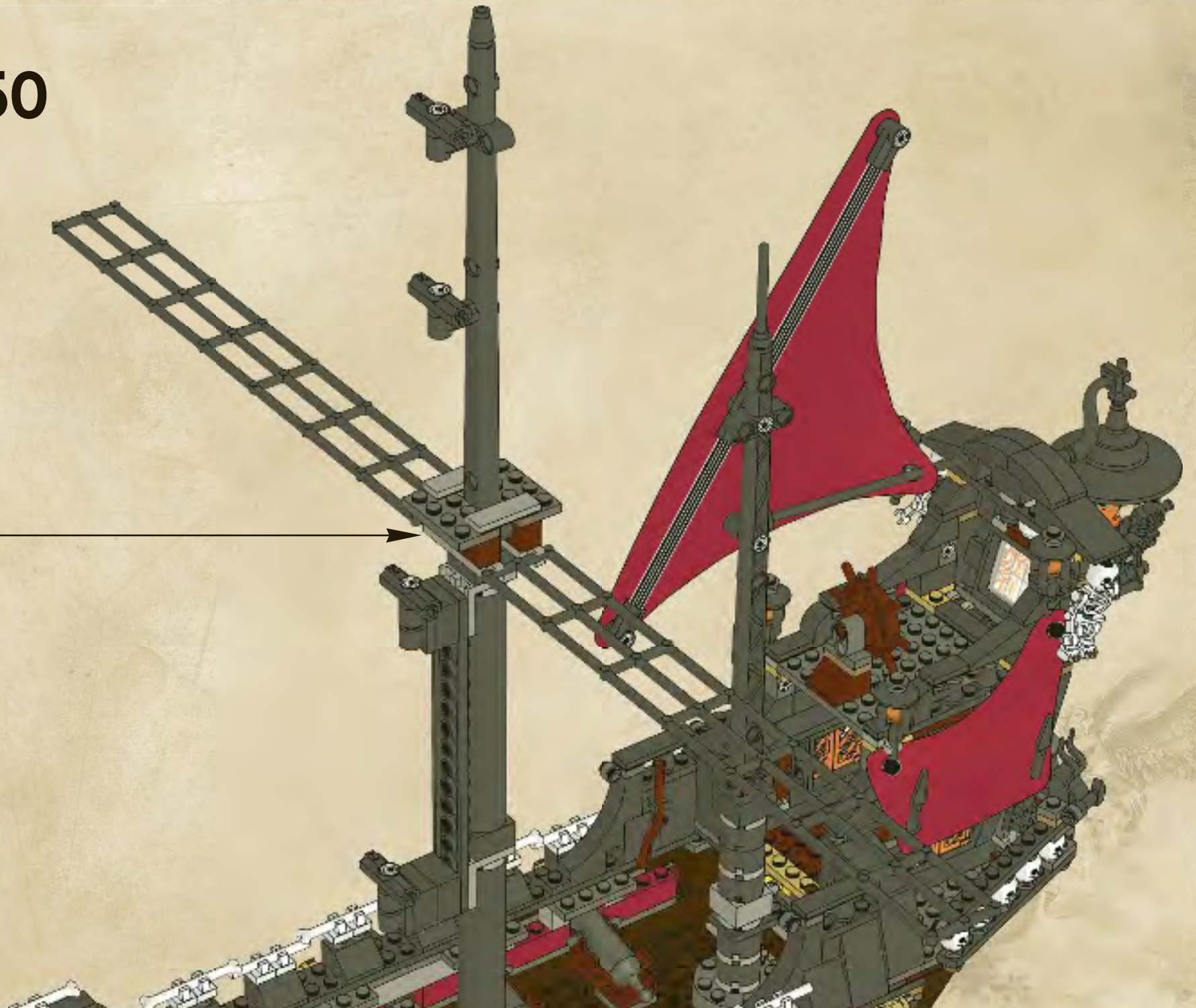

51

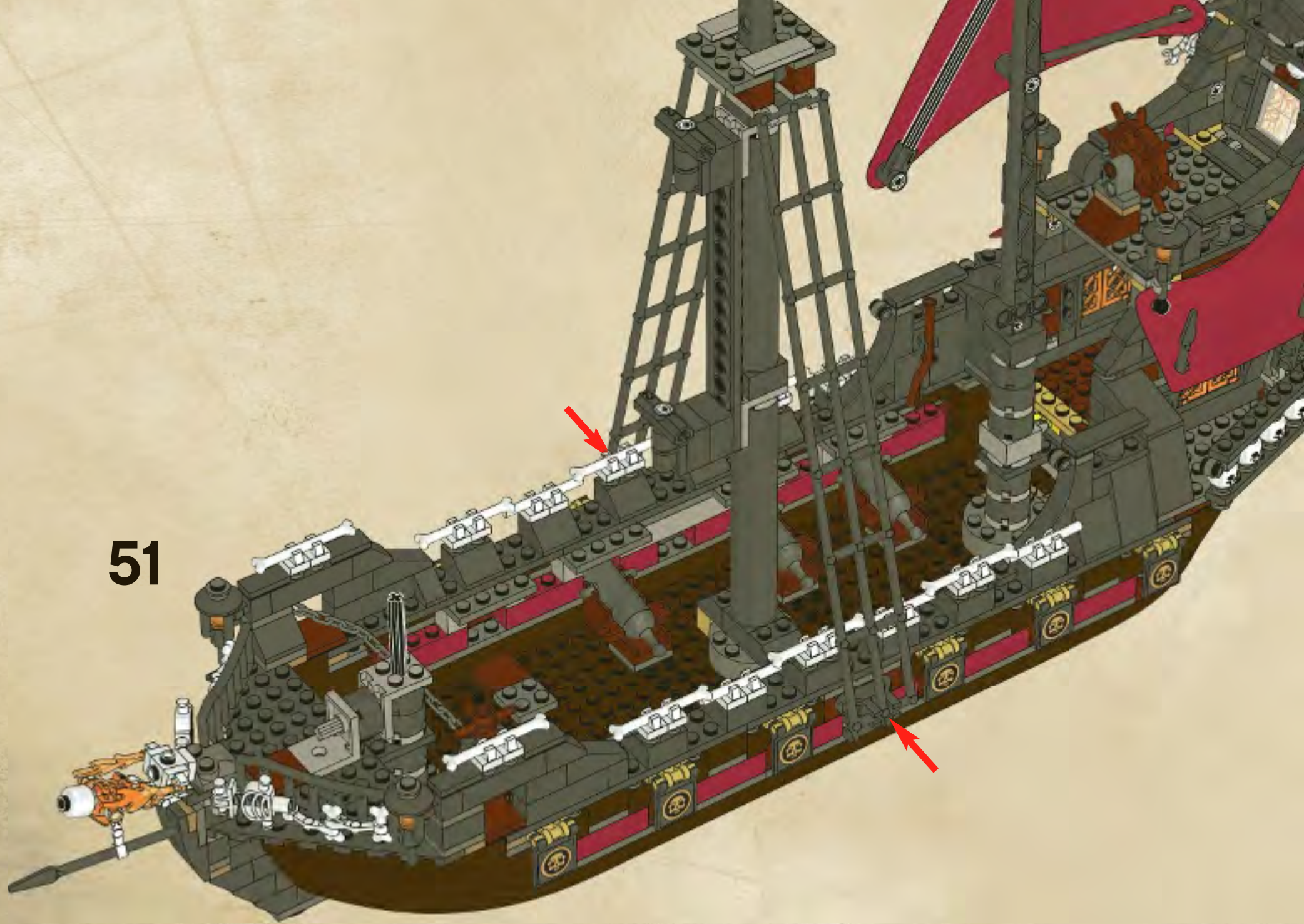



52





53

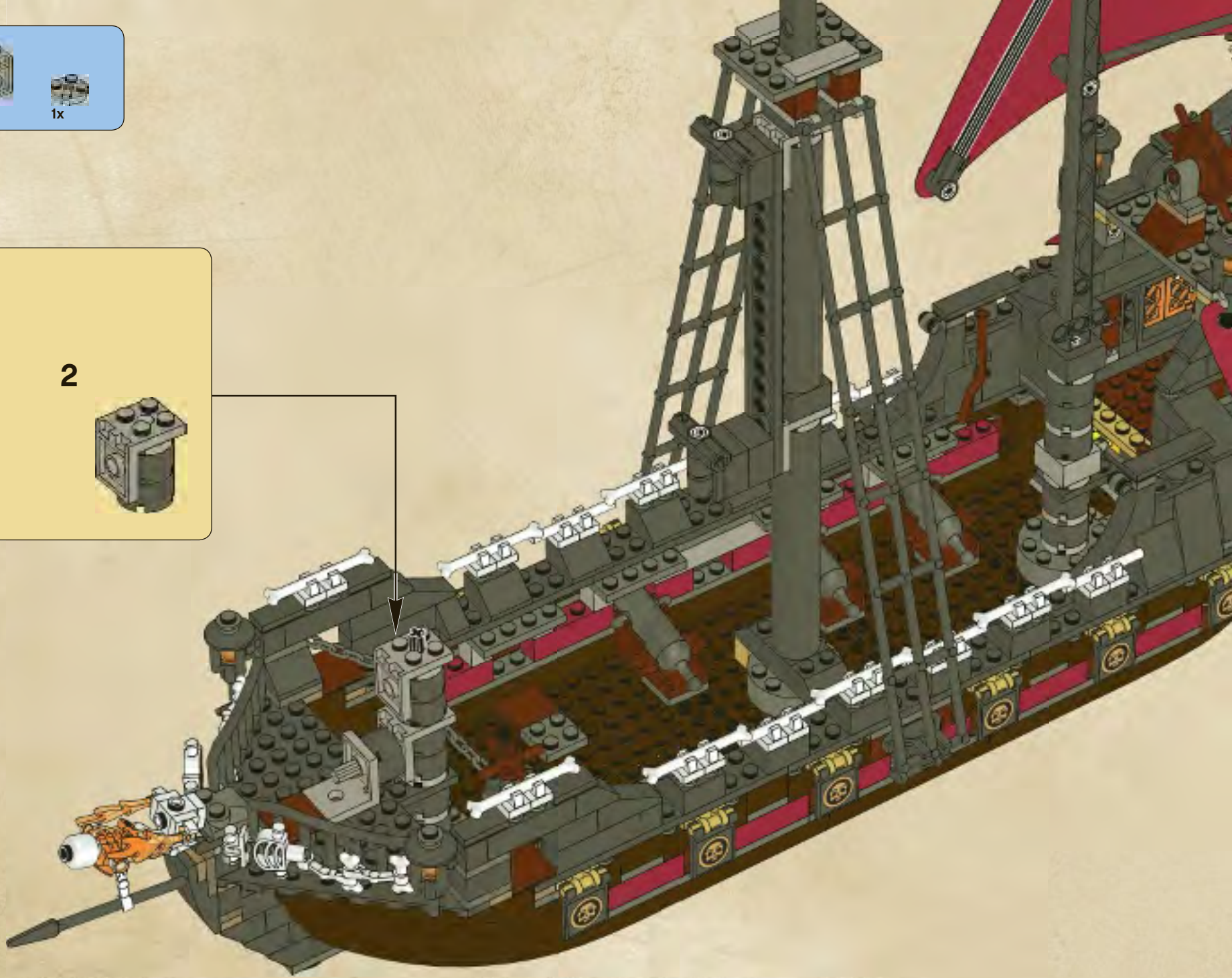
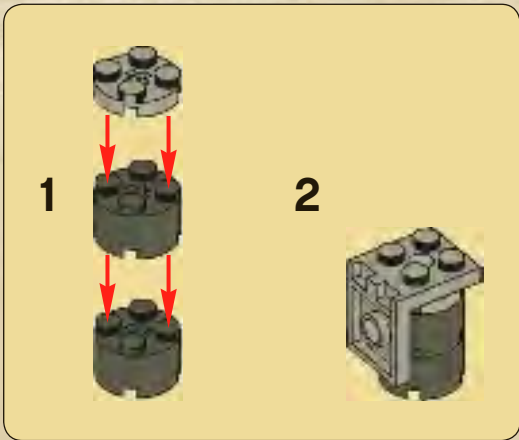



54

1



2



3



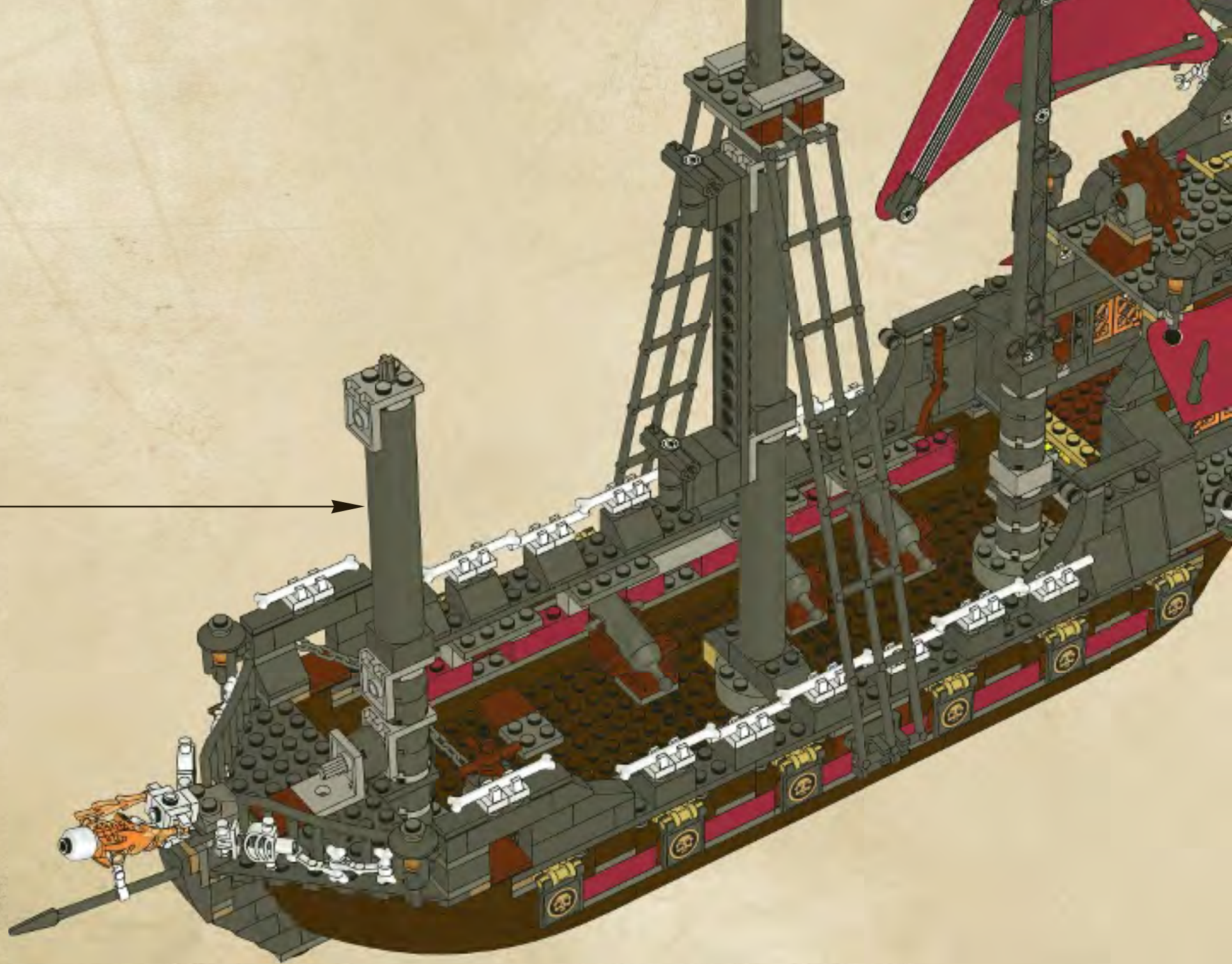

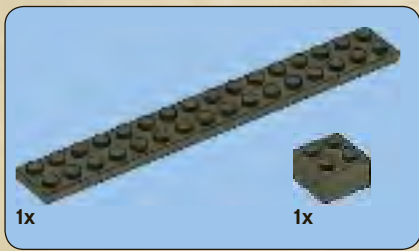

55

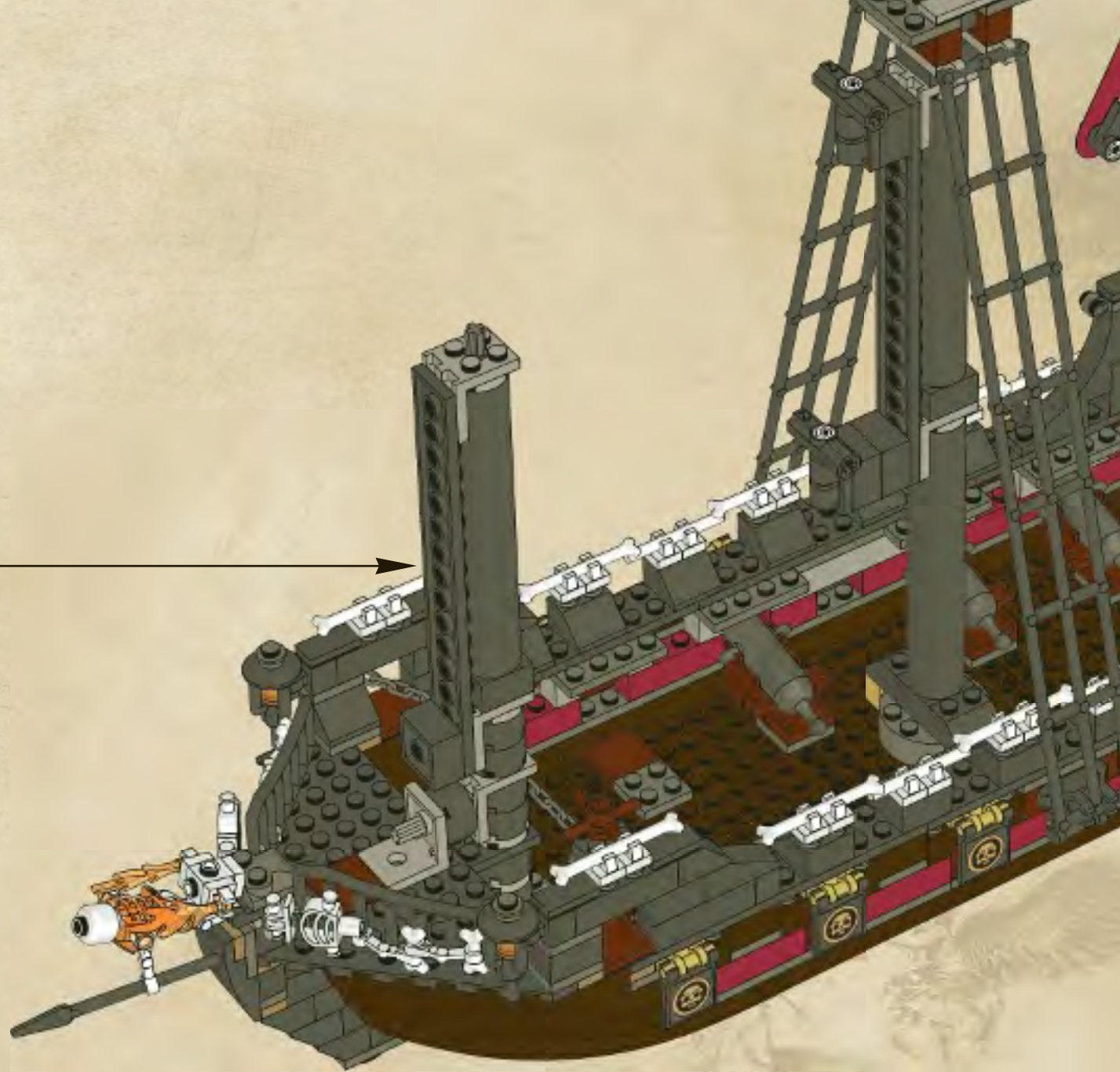



56

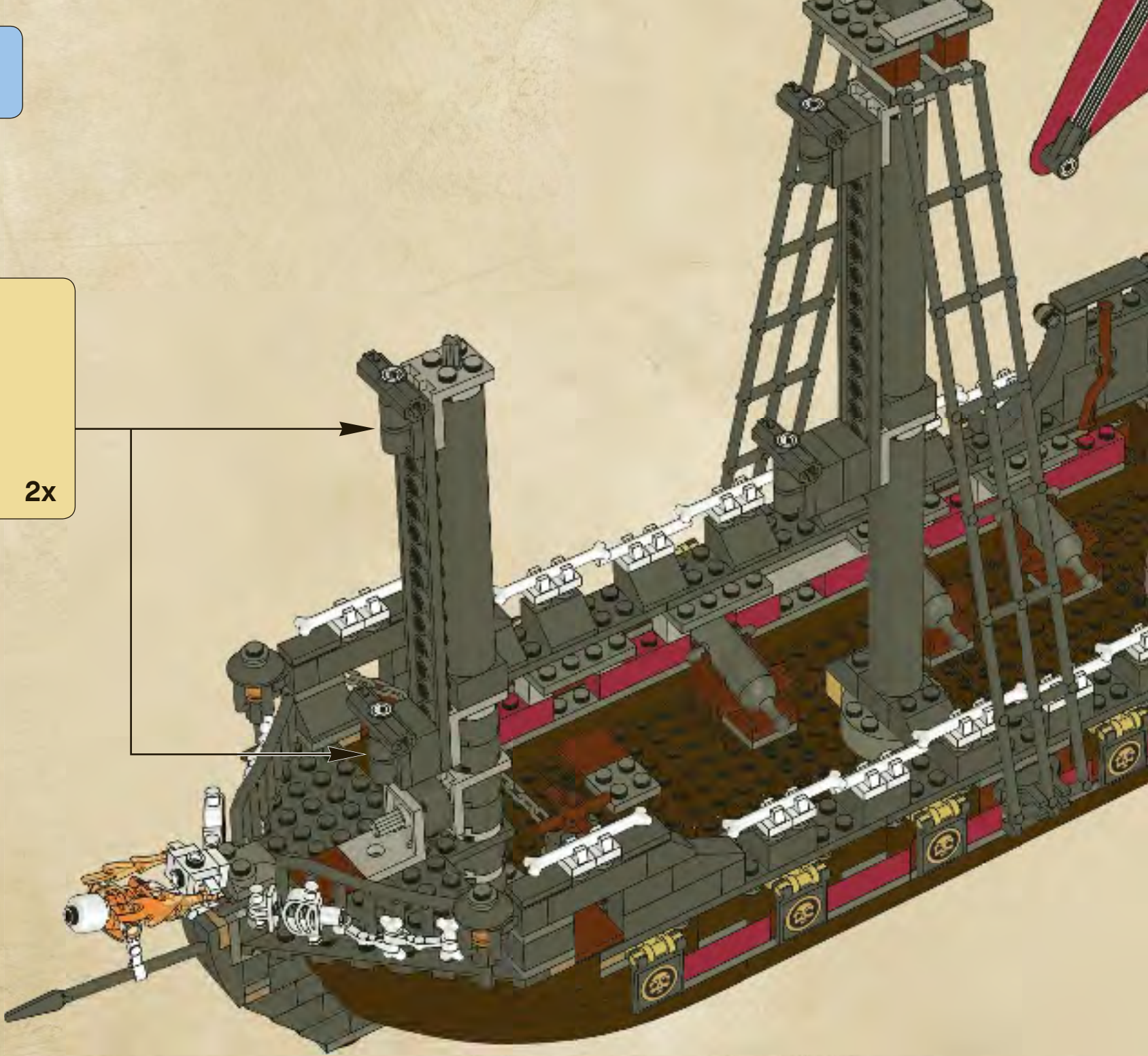
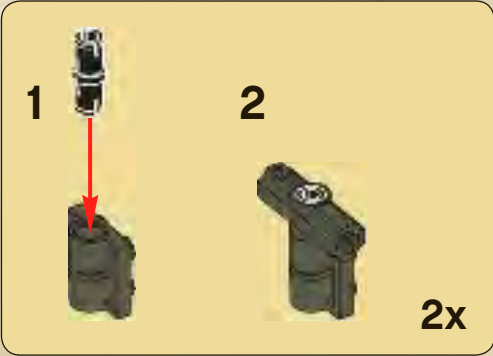



1



2



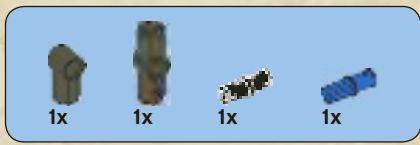

3

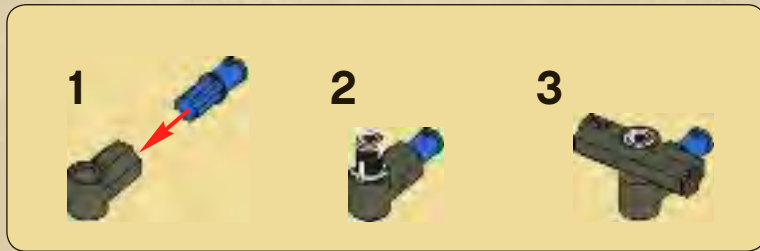

57

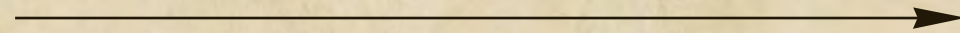

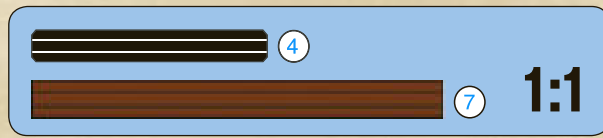
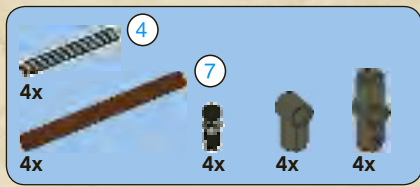

58

1



2



4x

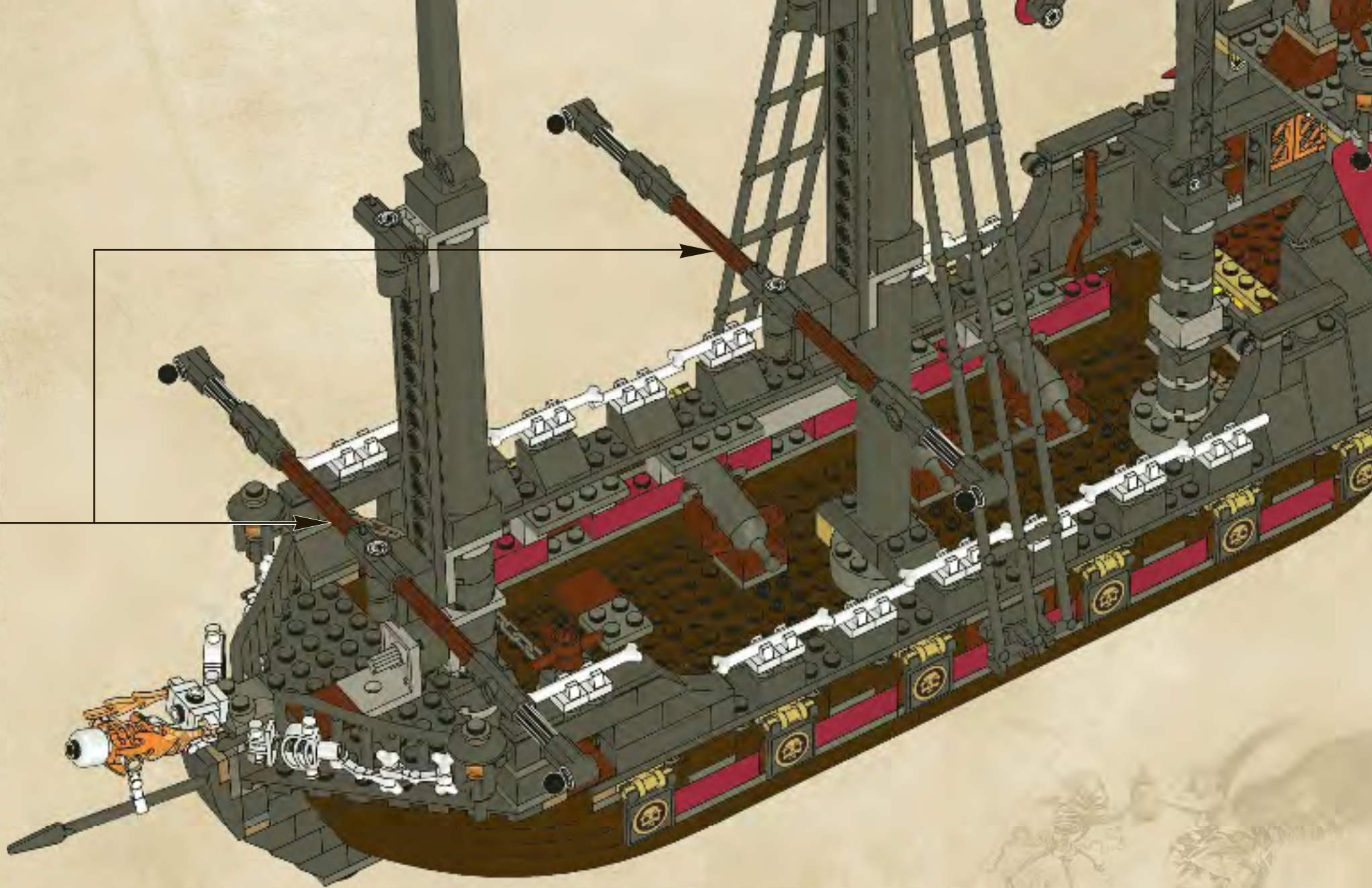

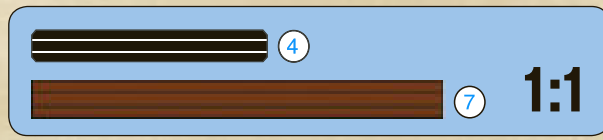
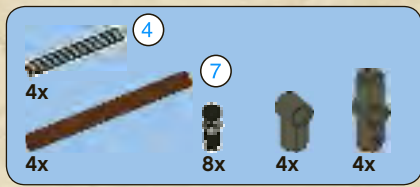

59

1



2



4x

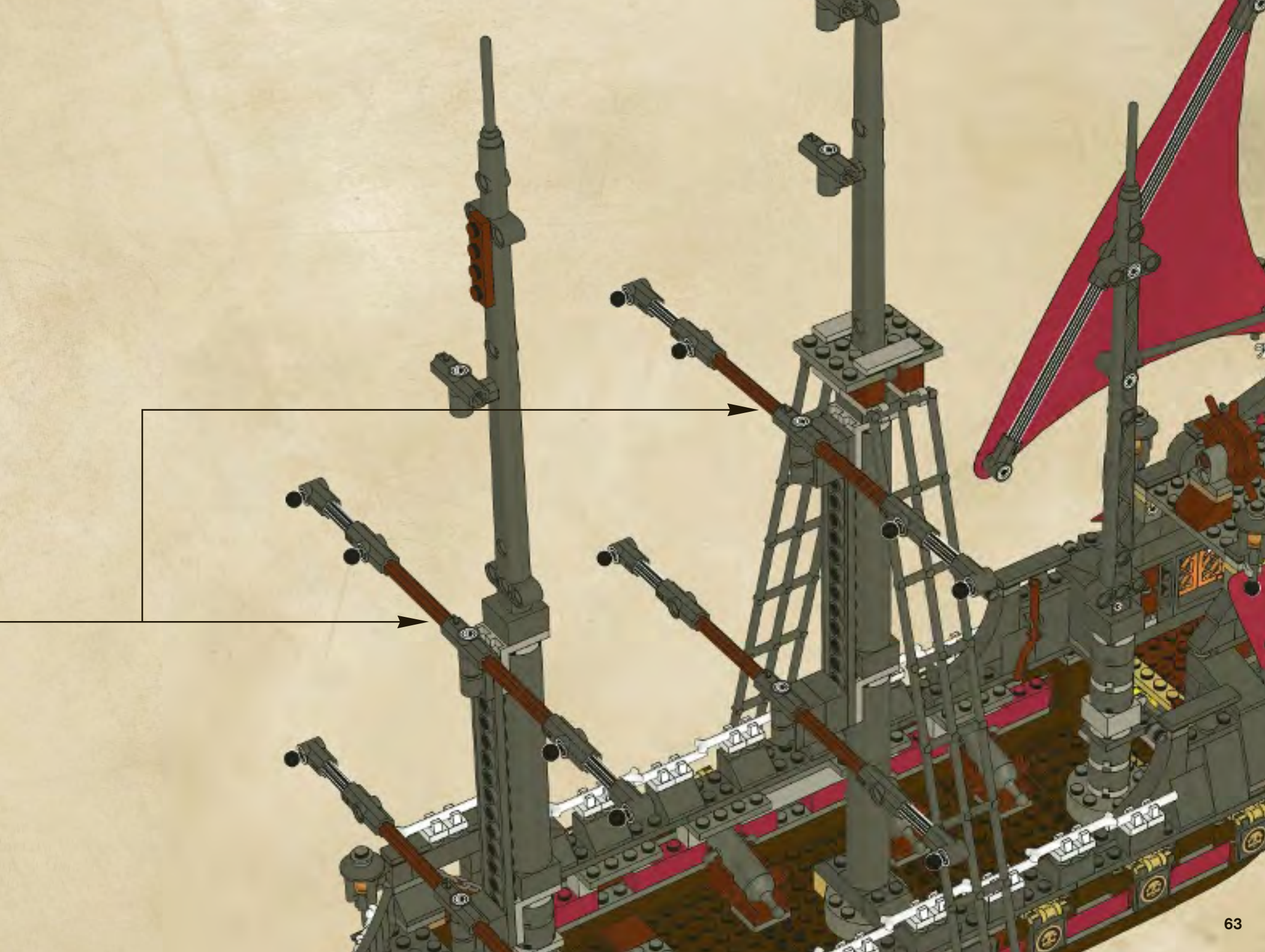



60

1





2



4x



2x  2x  2x 

 4 **1:1**

61

1  2  2x 



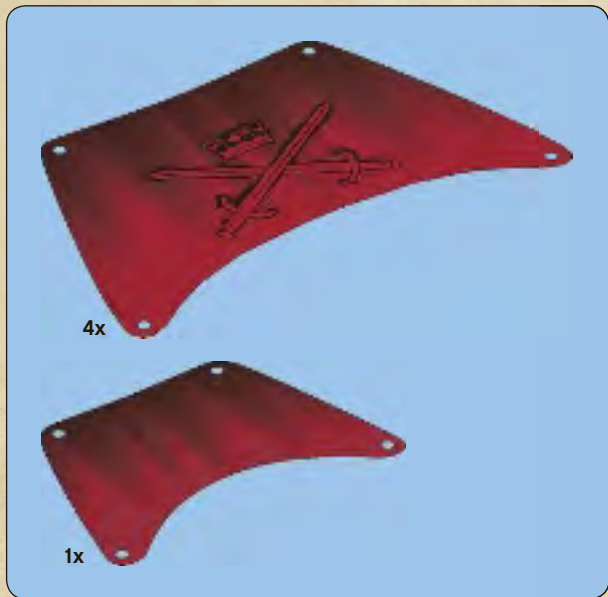

62



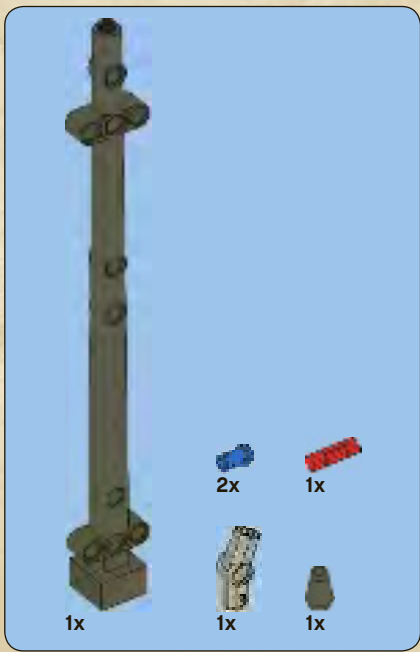

63





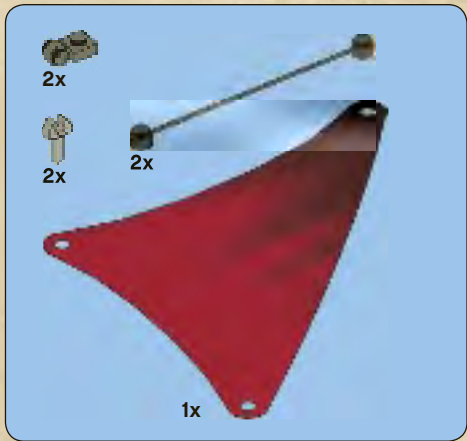

64

1



2



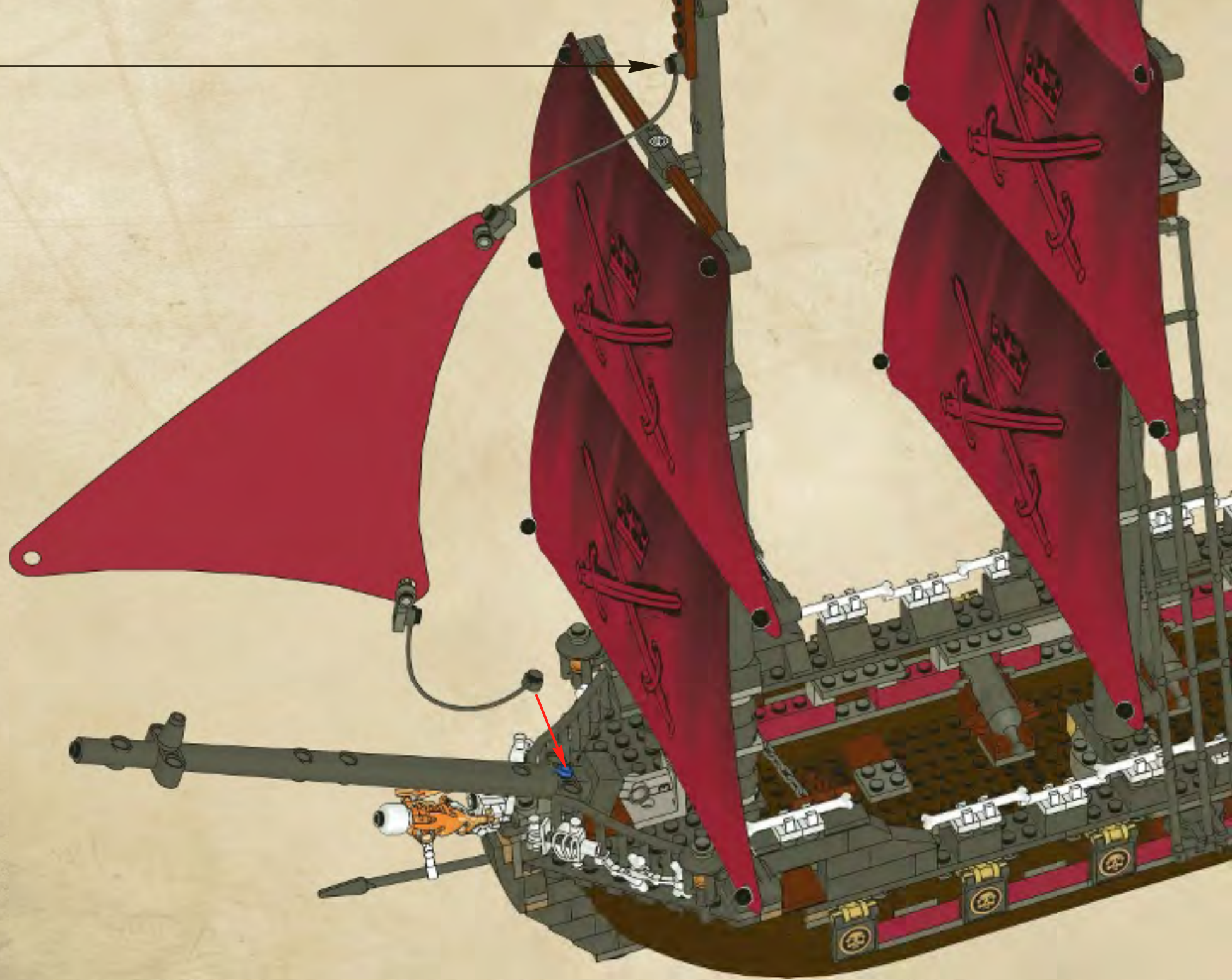



1x

65



66





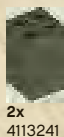

2x
4113241



5x
362326



6x
4558954



14x
4533771



2x
4118624



32x
4529236



13x
614326



12x
4121966



3x
4530589



1x
4535834

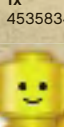

Customer Service

Kundenservice
Service Consommateurs
Servicio Al Consumidor

www.lego.com/service or dial



00800 5346 5555 :



1-800-422-5346 :

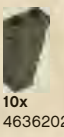

10x
4636202



1x
446026



2x
4273703



4x
4143982



15x
303926



3x
366026



2x
428626



2x
4515362



4x
4185583



4x
609126



1x
4526982



13x
255526



2x
4569733



9x
4225201



4x
281726



1x
4514342



17x
300426



12x
300326



1x
4636302



6x
4223247



2x
370926



2x
614126



7x
474026



1x
4180087



1x
4207127



2x
4522034



2x
4522034



12x
4523405



2x
4636201



1x
4636467



1x
9339



1x
4621786



1x
4626202



2x
4508144



1x
4637225



1x
4620188



1x
4631232



1x
4633355



2x
452226



4x
4251161



2x
4522034



2x
4522034



2x
4522034



2x
4620763



1x
4181144



22x
306926



4x
243126



2x
416226



6x
301026



4x
300926



2x
611126



2x
303426



9x
447726



7x
244526



2x
428226



2x
4205347



1x
4638275



1x
4638275



24x
4184169



16x
4107783



20x
4107085



2x
4220098



17x
4121715



2x
4116854



1x
4620400



2x
4620385



2x
395726



5x
449726



2x
384926



2x
4528331



10x
370526



1x
373726



3x
370826



1x
4296268



6x
4532220



3x
4541890



2x
4541896

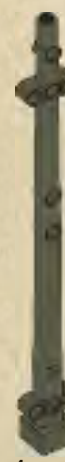

4x
4263506

4

10

12

7x
4109995

1x
4524449

2x
4114077

1x
4124067

1x
4113993

2x
4114324

6x
4160483

14x
4140593

11x
4278422

1x
4638255

1x
3006840

1x
4552033

1x
4639698

1x
4616027

12x
4211242

4x
4529242

3x
4211202

4x
4219726

8x
4211151

15x
4271949

4x
4267994

7x
4211190

1x
4211247

3x
4211214

12x
4631800

1x
4548857

1x
4211185

3x
4538718

1x
4636165

1x
4619510

1x
4636420

1x
4211147

1x
4252456

1x
4634032

1x
4626196

1x
4536847

2x
4211311

2x
4262974

1x
4636415

1x
4641324

1x
4625361

1x
4619544

1x
4634052

1x
4634076

1x
4634078

1x
4634079

4x
4143005

3x
4206482

2x
4514553

2x
4188357

1x
4185617

2x
4256320

2x
4620380

1x
4634033

3x
4142865

4x
4539104

8x
4541369

1x
4636164

1x
4630044

1x
4630319

2x
4630021

1x
4630043

4x
4625744

7





Disney PIRATES of the CARIBBEAN



videogames.LEGO.com



© Disney, LEGO® Pirates of the Caribbean: The Video Game software © 2011 TT Games Publishing Ltd. Produced by TT Games under license from the LEGO Group. LEGO, the LEGO logo, the Brick and the Knob configurations and the Minifigure are trademarks of the LEGO Group. © 2011 The LEGO Group.

© Disney, LEGO® Pirates of the Caribbean : Le logiciel du Jeu Vidéo © 2011 TT Games Publishing Ltd. Produit par TT Games sous licence du Groupe LEGO. LEGO, le logo LEGO, la figurine et les configurations de la brique et du tenon sont des marques de commerce du Groupe LEGO. © 2011 Le Groupe LEGO.





www.LEGOclub.com



LEGO® Club Email



LEGO® Club Magazine

LEGO club™

FREE! GRATIS! GRATUIT!

SIGN UP ONLINE!

www.LEGOclub.com

VISIT THE WORLD'S
BIGGEST LEGO® SHOP!
www.LEGOshop.com

GO TO
www.LEGOclub.com

00800 5346 5555*

1-866-534-6258 • 1-877-518-5346

US & Canada only

Canada seulement



* Freephone. Mobile charges may apply.
* Numéro sans frais. Des frais peuvent s'appliquer avec les téléphones cellulaires.
* Gebührenfrei, Kosten für Anrufe aus Mobilfunknetzen können abweichen.
* Gratis telefonnummer vanaf vaste lijn.
* Det er et gratis nummer, når du ringer fra fasttelefon.
* Det är gratis, när du ringer från en fast telefon.
* Numéro sans frais. Des frais peuvent s'appliquer avec les téléphones portables.



WIN!

Go to www.LEGOsurvey.com/product to fill out a survey for a chance to win a cool LEGO® Product. No purchase necessary. Open to all residents where not prohibited.



www.LEGO.com



www.LEGOsurvey.com/product

GEWINNE!

Nimm an der Umfrage auf www.LEGOsurvey.com/product teil und hab die Chance ein cooles LEGO® Produkt zu gewinnen!

Die Teilnahme am Gewinnspiel führt zu keinerlei Kaufverpflichtungen. Teilnahme in allen nicht ausgeschlossenen Ländern möglich.

WIN!

Ga naar www.LEGOsurvey.com/product, vul een enquêteformulier in en maak kans op een cool LEGO® product.

Geen aankoopverplichting. Iedereen mag deelnemen, uitgezonderd ingezetenden van landen waar een enquêteverbod geldt.

GAGNE!

Visite www.LEGOsurvey.com/product pour répondre à un questionnaire et avoir une chance de gagner un produit LEGO® très cool!

Aucune obligation d'achat. Ouvert à tous les résidents des pays autorisés.

当てよう!

www.LEGOsurvey.com/product にアクセスして、アンケートにご記入ください。当選者にはレゴ®製品を差し上げます。

お買い上げの必要はありません。禁止されていない限り、すべての皆様にご利用いただけます。